



ETA-Danmark A/S
Göteborg Plads 1
DK-2150 Nordhavn
Tel. +45 72 24 59 00
Fax +45 72 24 59 04
Internet www.etadanmark.dk

Authorised and notified according
to Article 29 of the Regulation (EU)
No 305/2011 of the European
Parliament and of the Council of 9
March 2011

MEMBER OF EOTA



European Technical Assessment ETA-11/0030 of 2016-04-07

I General Part

Technical Assessment Body issuing the ETA and designated according to Article 29 of the Regulation (EU) No 305/2011: ETA-Danmark A/S

Trade name of the construction product:

Rotho Blaas Self-tapping screws*)

Product family to which the above construction product belongs:

Screws for use in timber constructions

Manufacturer:

Rotho Blaas s.r.l
Via dell'Adige 2/1
IT-38040 Cortaccia (BZ)
Tel. + 39 0471 818400
Fax + 39 0471 818484
Internet www.rothoblaas.com

Manufacturing plant:

Rotho Blaas s.r.l
Manufacturing Plants: S1, S2, S3, S4, S5, S6, S7, S8, S9, S10

This European Technical Assessment contains:

47 pages including 4 annexes which form an integral part of the document

This European Technical Assessment is issued in accordance with Regulation (EU) No 305/2011, on the basis of:

European Assessment document (EAD) no. EAD 130118-00-0603 "Screws for timber constructions"

This version replaces:

The previous ETA with the same number issued on 2012-11-08 and expiry on 2016-04-05

*) See section II.1 of this ETA

Translations of this European Technical Assessment in other languages shall fully correspond to the original issued document and should be identified as such.

Communication of this European Technical Assessment, including transmission by electronic means, shall be in full (excepted the confidential Annex(es) referred to above). However, partial reproduction may be made, with the written consent of the issuing Technical Assessment Body. Any partial reproduction has to be identified as such.

II SPECIFIC PART OF THE EUROPEAN TECHNICAL ASSESSMENT

1 Technical description of product and intended use

Technical description of the product

Rotho Blaas “HBS”, “HBS+”, “TBS”, “KKF”, “SCI”, “VGS”, “VGZ”, “DGZ”, “KKT” and “LBS” screws are self-tapping screws to be used in timber structures. “HBS” screws are also called “SCH”, “GHS”, “PSC”, “SENK”, “HTP”, “SNK” or “HTS” screws, “HBS+” screws are also called “GHS+”, “KEGEL”, “KGL” or “HTK” screws, “KKF” screws are also called „GHKF”, “KEGEL410”, “KGA” or “HTK4” screws and “TBS” screws are also called “GHSK”, “TELLER”, “TLL” or “HTT” screws, “VGS” screws are also called “GWS” screws, “VGZ” screws are also called “GWZ” screws, “KKT” screws are also called “MNA”, “MNG” or “MNB” screws. Rotho Blaas “HBS”, “HBS+”, “TBS”, “KKF” and “SCI” screws shall be threaded over a part of the length. Rotho Blaas “VGS”, “VGZ” and “LBS” screws shall be threaded over the full length. Rotho Blaas “DGZ” and “KKT” screws shall have two threaded parts over the length. The screws shall be produced from carbon steel wire for nominal diameters of 3,0 mm to 12,0 mm and from stainless steel wire for nominal diameters of 3,5 mm to 8,0 mm. Where corrosion protection is required, the material or coating shall be declared in accordance with the relevant specification given in Annex A of EN 14592.

Geometry and Material

The nominal diameter (outer thread diameter), d , shall not be less than 3,0 mm and shall not be greater than 12,0 mm. The overall length, L , of screws shall not be less than 20 mm and shall not be greater than 600 mm. Other dimensions are given in Annex A.

Screw types “HBS”, “SCH”, “GHS”, “PSC”, “HTP”, “SENK”, “SNK”, “HTS”, “HBS+”, “GHS+”, “KEGEL”, “KGL”, “HTK”, “TBS”, „GHSK”, “TELLER”, “TLL”, “HTT”, “DGZ”, “LBS”, “VGS”, “GWS”, “VGZ” and “GWZ” are made from carbon steel.

Screw types “KKF” and “GHKF” are made from martensitic stainless steel 1.4006 and SCI are made from stainless steel grade 1.4401 or 1.4567.

Screw types “KKT” are made from either carbon steel or stainless steel.

The ratio of inner thread diameter to outer thread diameter d_i/d ranges from 0,55 to 0,71.

The screws are threaded over a minimum length l_g of $3,3 \cdot d$ (i.e. $l_g \geq 3,3 \cdot d$).

The lead p (distance between two adjacent thread flanks) ranges from $0,43 \cdot d$ to $0,76 \cdot d$.

No breaking shall be observed at a bend angle, α , of less than $(45/d^{0.7} + 20)$ degrees.

2 Specification of the intended use in accordance with the applicable EAD

The screws are used for connections in load bearing timber structures between members of solid timber (softwood), glued laminated timber, cross-laminated timber, and laminated veneer lumber, similar glued members, wood-based panels or steel. Rotho Blaas “VGS” and “VGZ” screws are also used as tensile or compressive reinforcement perpendicular to the grain.

Furthermore Rotho Blaas screws with diameters between 6 mm and 12 mm may also be used for the fixing of thermal insulation material on rafters and on vertical facades.

Steel plates and wood-based panels except solid wood panels and cross laminated timber shall only be located on the side of the screw head. The following wood-based panels may be used:

- Plywood according to EN 636 or ETA
- Particleboard according to EN 312 or ETA
- Oriented Strand Board, Type OSB/3 and OSB/4 according to EN 300 or ETA
- Fibreboard according to EN 622-2 and 622-3 or ETA (minimum density 650 kg/m³)
- Cement bonded particleboard
- Solid wood panels according to EN 13353 and EN 13986 and cross laminated timber according to ETA
- Laminated Veneer Lumber, LVL
- Engineered wood products according to ETA, provided that the ETA for the product provides provisions for the use of self-tapping screws and these provisions are applied

The screws shall be driven into the wood without pre-drilling or after pre-drilling with a diameter not larger than the inner thread diameter.

The screws are intended to be used in timber connections for which requirements for mechanical resistance and stability and safety in use in the sense of the Basic Works Requirements 1 and 4 of Regulation 305/2011 (EU) shall be fulfilled.

The design of the connections shall be based on the characteristic load-carrying capacities of the screws. The design capacities shall be derived from the characteristic capacities in accordance with Eurocode 5 or an appropriate national code (e.g. DIN 1052:2008-12).

The screws are intended for use for connections subject to static or quasi static loading.

Section 3.11 of this ETA contains the corrosion protection for Rotho Blaas screws made from carbon steel and the material number of the stainless steel. The martensitic stainless steel screws are for use in timber structures subject to the conditions defined by the service classes 1, 2 and 3 of EN 1995-1-1 (Eurocode 5).

The scope of the screws regarding resistance to corrosion shall be defined according to national provisions that apply at the installation site considering environmental conditions.

The provisions made in this European Technical Assessment are based on an assumed intended working life of the screws of 50 years.

The indications given on the working life cannot be interpreted as a guarantee given by the producer or Assessment Body, but are to be regarded only as a means for choosing the right products in relation to the expected economically reasonable working life of the works.

3 Performance of the product and references to the methods used for its assessment

Characteristic	Assessment of characteristic
3.1 Mechanical resistance and stability*) (BWR1)	
Tensile strength	Characteristic value $f_{\text{tens},k}$:
Screw made from carbon steel "HBS", "SCH", "GHS", "PSC", "HTP", "SENK", "SNK", "HTS", "HBS+", "GHS+", "KEGEL", "KGL", "HTK", "TBS", "GHSK", "TELLER", "TLL", "HTT", "DGZ", "LBS", "VGS", "GWS", "VGZ", "GWZ", "KKT", "MNB" and "MNG" and screws made from stainless steel "KKT", "MNA", "MNB", "MNG", "KKF" and "GHKF" screws	Screw d = 3,0 mm: 2,8 kN
	Screw d = 3,5 mm: 3,8 kN
	Screw d = 4,0 mm: 5,0 kN
	Screw d = 4,5 mm: 6,4 kN
	Screw d = 5,0 mm: 7,9 kN
	Screw d = 6,0 mm: 11,3 kN
	Screw d = 7,0 mm: 15,4 kN
	Screw d = 8,0 mm: 20,1 kN
	Screw d = 9,0 mm: 25,4 kN
	Screw d = 10,0 mm: 31,4 kN
Screws made from stainless steel "SCI"	Screw d = 3,5 mm: 2,1 kN
	Screw d = 4,0 mm: 2,8 kN
	Screw d = 4,5 mm: 3,5 kN
	Screw d = 5,0 mm: 4,3 kN
	Screw d = 6,0 mm: 6,2 kN
Insertion moment	Ratio of the characteristic torsional strength to the mean insertion moment: $f_{\text{tor},k} / R_{\text{tor,mean}} \geq 1,5$
	Characteristic value $f_{\text{tor},k}$:
Torsional strength	
"HBS", "SCH", "GHS", "PSC", "HTP", "SENK", "SNK", "HTS", "HBS+", "GHS+", "KEGEL", "KGL", "HTK", "TBS", "GHSK", "TELLER", "TLL", "HTT", "KKF", "GHKF", "KEGEL410", "KGA", "HTK4", "VGS", "GWS", "VGZ", "GWZ" and "DGZ" screws	Screw d = 3,0 mm: 1,3 Nm
	Screw d = 3,5 mm: 2,0 Nm
	Screw d = 4,0 mm: 3,0 Nm
	Screw d = 4,5 mm: 5,0 Nm
	Screw d = 5,0 mm: 7,5 Nm
	Screw d = 6,0 mm: 12,0 Nm
	Screw d = 7,0 mm: 18,0 Nm
	Screw d = 8,0 mm: 28,0 Nm
	Screw d = 9,0 mm: 35,0 Nm
	Screw d = 10,0 mm: 40,0 Nm
"KKT", "MNA", "MNB", "MNG", "SCI" and "LBS" screws	Screw d = 11,0 mm: 60,0 Nm
	Screw d = 12,0 mm: 60,0 Nm
	Screw d = 3,5 mm: 1,5 Nm
	Screw d = 4,0 mm: 2,0 Nm
	Screw d = 4,5 mm: 3,0 Nm
	Screw d = 5,0 mm: 5,0 Nm
	Screw d = 6,0 mm: 8,0 Nm
	Screw d = 8,0 mm: 18,0 Nm

Characteristic	Assessment of characteristic
3.2 Safety in case of fire (BWR2)	
Reaction to fire	The screws are made from steel classified as performance class A1 of the characteristic reaction to fire, in accordance with the provisions of EC decision 96/603/EC, amended by EC Decision 2000/605/EC.
3.3 Hygiene, health and the environment (BWR3)	
Influence on air quality	The product does not contain/release dangerous substances specified in TR 034, dated March 2012 (**)
3.7 Sustainable use of natural resources (BR7)	No Performance Determined
3.8 General aspects related to the performance of the product	The screws have been assessed as having satisfactory durability and serviceability when used in timber structures using the timber species described in Eurocode 5 and subject to the conditions defined by service classes 1, 2 and 3
Identification	See Annex A

*) See additional information in section 3.9 – 3.12.

**) In addition to the specific clauses relating to dangerous substances contained in this European technical Assessment, there may be other requirements applicable to the products falling within its scope (e.g. transposed European legislation and national laws, regulations and administrative provisions). In order to meet the provisions of the Construction Products Regulation, these requirements need also to be complied with, when and where they apply.

3.9 Mechanical resistance and stability

The load-carrying capacities for Rotho Blaas screws are applicable to the wood-based materials mentioned in paragraph 1 even though the term timber has been used in the following.

The characteristic lateral load-carrying capacities and the characteristic axial withdrawal capacities of Rotho Blaas screws should be used for designs in accordance with Eurocode 5 or an appropriate national code.

Pointside penetration length must be $\ell_{ef} \geq 4 \cdot d$, where d is the outer thread diameter of the screw. For the fixing of rafters, point side penetration must be at least 40 mm, $\ell_{ef} \geq 40$ mm.

ETA's for structural members may be considered if applicable.

For wood-based panels the relevant ETA's must be considered where applicable.

Lateral load-carrying capacity

The characteristic lateral load-carrying capacity of Rotho Blaas screws shall be calculated according to EN 1995-1-1:2008 (Eurocode 5) using the outer thread diameter d as the nominal diameter of the screw.

The characteristic yield moment shall be calculated from:

Rotho Blaas screws made from carbon steel and "KKT" and "KKF" screws made from stainless steel for $3,0 \text{ mm} \leq d \leq 5,0 \text{ mm}$:

$$M_{y,k} = 0,15 \cdot 550 \text{ (N/mm}^2\text{)} \cdot d^{2,6} \text{ [Nmm]}$$

Rotho Blaas screws made from carbon steel and "KKT" and "KKF" screws made from stainless steel for $6,0 \text{ mm} \leq d \leq 11,0 \text{ mm}$:

$$M_{y,k} = 0,15 \cdot 600 \text{ (N/mm}^2\text{)} \cdot d^{2,6} \text{ [Nmm]}$$

Rotho Blaas screws made from carbon steel for $d = 12,0 \text{ mm}$:

$$M_{y,k} = 0,15 \cdot 500 \text{ (N/mm}^2\text{)} \cdot d^{2,6} \text{ [Nmm]}$$

Rotho Blaas screws made from stainless steel "SCI":

$$M_{y,k} = 0,15 \cdot 220 \text{ (N/mm}^2\text{)} \cdot d^{2,6} \text{ [Nmm]}$$

where

d outer thread diameter [mm]

Axial withdrawal capacity

The characteristic axial withdrawal capacity of Rotho Blaas screws in solid timber (softwood), glued laminated timber or cross-laminated timber members at an angle of $30^\circ \leq \alpha \leq 90^\circ$ to the grain shall be calculated according to EN 1995-1-1:2008 from:

$$F_{ax,\alpha,Rk} = \frac{n_{ef} \cdot 11,7 \cdot d \cdot \ell_{ef}}{1,2 \cdot \cos^2 \alpha + \sin^2 \alpha} \cdot \left(\frac{\rho_k}{350} \right)^{0,8} \text{ [N]} \quad [N]$$

where

$F_{ax,\alpha,Rk}$	characteristic withdrawal capacity of the screw at an angle α to the grain [N]
n_{ef}	effective number of screws according to EN 1995-1-1:2008
d	outer thread diameter [mm]
ℓ_{ef}	pointside penetration length of the threaded part according to EN 1995-1-1:2008 [mm]
α	angle between grain and screw axis ($\alpha \geq 30^\circ$)
ρ_k	characteristic density [kg/m ³]

The axial withdrawal capacity is limited by the head pull-through capacity and the tensile strength of the screw.

Bending angle

A minimum plastic bending angle of $45^\circ/d^{0,7} + 20^\circ$ was reached without breaking the screws.

Head pull-through capacity

The characteristic head pull-through capacity of Rotho Blaas screws in softwoods and wood-based panels shall be calculated according to EN 1995-1-1:2008 from:

$$F_{ax,\alpha,Rk} = n_{ef} \cdot f_{head,k} \cdot d_h^2 \cdot \left(\frac{\rho_k}{350} \right)^{0,8} \text{ [N]} \quad [N]$$

where:

$F_{ax,\alpha,Rk}$	characteristic head pull-through capacity of the connection at an angle $\alpha \geq 30^\circ$ to the grain [N]
n_{ef}	effective number of screws according to EN 1995-1-1:2008
$f_{head,k}$	characteristic head pull-through parameter [N/mm ²]
d_h	diameter of the screw head [mm]
ρ_k	characteristic density [kg/m ³], for wood-based panels $\rho_k = 380 \text{ kg/m}^3$

Characteristic head pull-through parameter for Rotho Blaas screws or for washer except "KKF" and "KKT" screws in connections with softwood and in connections with wood-based panels with thicknesses above 20 mm:
 $f_{head,k} = 10,5 \text{ N/mm}^2$

Characteristic head pull-through parameter for Rotho Blaas "KKF" and "KKT" screws in connections with softwood and in connections with wood-based panels with thicknesses above 20 mm:
 $f_{head,k} = 16,5 \text{ N/mm}^2$

Characteristic head pull-through parameter for screws in connections with wood-based panels with thicknesses between 12 mm and 20 mm:
 $f_{head,k} = 8 \text{ N/mm}^2$

Screws in connections with wood-based panels with a thickness below 12 mm (minimum thickness of the wood based panels of $1,2 \cdot d$ with d as outer thread diameter):

$$f_{\text{head,k}} = 8 \text{ N/mm}^2$$

limited to $F_{\text{ax,Rk}} = 400 \text{ N}$

The head diameter d_h of all screws except “KKF” and “KKT” screws shall be greater than $1,8 \cdot d_s$, where d_s is the smooth shank or the wire diameter. Otherwise the characteristic head pull-through capacity $F_{\text{ax},\alpha,\text{Rk}} = 0$.

The minimum thickness of wood-based panels according to the clause 3.9 must be observed.

In steel-to-timber connections the head pull-through capacity may be disregarded.

Tensile capacity

The characteristic tensile strength $f_{\text{tens,k}}$ of screws made from carbon steel and “KKF” and “KKT” screws made from stainless steel is:

Screw $d = 3,0 \text{ mm}$:	2,8 kN
Screw $d = 3,5 \text{ mm}$:	3,8 kN
Screw $d = 4,0 \text{ mm}$:	5,0 kN
Screw $d = 4,5 \text{ mm}$:	6,4 kN
Screw $d = 5,0 \text{ mm}$:	7,9 kN
Screw $d = 6,0 \text{ mm}$:	11,3 kN
Screw $d = 7,0 \text{ mm}$:	15,4 kN
Screw $d = 8,0 \text{ mm}$:	20,1 kN
Screw $d = 9,0 \text{ mm}$:	25,4 kN
Screw $d = 10,0 \text{ mm}$:	31,4 kN
Screw $d = 11,0 \text{ mm}$:	38,0 kN
Screw $d = 12,0 \text{ mm}$:	33,9 kN

Screws made from stainless steel “SCI“:

Screw $d = 3,5 \text{ mm}$:	2,1 kN
Screw $d = 4,0 \text{ mm}$:	2,8 kN
Screw $d = 4,5 \text{ mm}$:	3,5 kN
Screw $d = 5,0 \text{ mm}$:	4,3 kN
Screw $d = 6,0 \text{ mm}$:	6,2 kN
Screw $d = 8,0 \text{ mm}$:	11,1 kN

For screws used in combination with steel plates, the tear-off capacity of the screw head should be greater than the tensile strength of the screw.

Combined laterally and axially loaded screws

For screwed connections subjected to a combination of axial and lateral load, the following expression should be satisfied:

$$\left(\frac{F_{\text{ax,Ed}}}{F_{\text{ax,Rd}}} \right)^2 + \left(\frac{F_{\text{la,Ed}}}{F_{\text{la,Rd}}} \right)^2 \leq 1$$

where

$F_{\text{ax,Ed}}$	axial design load of the screw
$F_{\text{la,Ed}}$	lateral design load of the screw
$F_{\text{ax,Rd}}$	design load-carrying capacity of an axially loaded screw

$F_{\text{la,Rd}}$ design load-carrying capacity of a laterally loaded screw

Mechanically jointed beams

“VGS” and “VGZ” screws with a full thread may be used for connections in structural members which are composed of several parts in mechanically jointed beams or columns.

The axial slip modulus K_{ser} of a screw with a full thread for the serviceability limit state should be taken independent of angle α to the grain as:

$$C = K_{\text{ser}} = 780 \cdot d^{0,2} \cdot \ell_{\text{ef}}^{0,4} \quad [\text{N/mm}]$$

where

d	outer thread diameter [mm]
ℓ_{ef}	penetration length in the structural member [mm] (ℓ_1 or ℓ_2) (see Annex B)

Compression reinforcement

“VGS” and “VGZ” screws with a full thread may be used for reinforcement of timber members with compression stresses at an angle α to the grain of $45^\circ < \alpha < 90^\circ$. The compression force must be evenly distributed over all screws.

The characteristic load-carrying capacity for a contact area with screws with a full thread at an angle α to the grain of $45^\circ \leq \alpha \leq 90^\circ$ shall be calculated from:

$$F_{90,\text{Rk}} = \min \left\{ \begin{array}{l} k_{\text{c},90} \cdot B \cdot \ell_{\text{ef},1} \cdot f_{\text{c},90,\text{k}} + n \cdot \min(F_{\text{ax,Rk}}, F_{\text{ki,Rk}}) \\ B \cdot \ell_{\text{ef},2} \cdot f_{\text{c},90,\text{k}} \end{array} \right.$$

where

$F_{90,\text{Rk}}$	load-carrying capacity of reinforced contact area [N]
$k_{\text{c},90}$	factor for compression perpendicular to the grain according to EN 1995-1-1:2008, 6.1.5
B	bearing width [mm]
$\ell_{\text{ef},1}$	effective length of contact area according to EN 1995-1-1:2008, 6.1.5 [mm]
$f_{\text{c},90,\text{k}}$	characteristic compressive strength perpendicular to the grain [N/mm^2]
n	number of reinforcement screws, $n = n_0 \cdot n_{90}$
n_0	number of reinforcement screws arranged in a row parallel to the grain
n_{90}	number of reinforcement screws arranged in a row perpendicular to the grain
$F_{\text{ax,Rk}}$	characteristic axial withdrawal capacity [N]
$F_{\text{ki,Rk}}$	characteristic buckling capacity [N]
$\ell_{\text{ef},2}$	effective distribution length in the plane of the screw tips [mm]
$\ell_{\text{ef},2}$	$= \ell_{\text{ef}} + (n_0 - 1) \cdot a_1 + \min(\ell_{\text{ef}}, a_{1,\text{c}})$ for reinforced end-bearings [mm]
$\ell_{\text{ef},2}$	$= 2 \cdot \ell_{\text{ef}} + (n_0 - 1) \cdot a_1$ for reinforced centre-bearings [mm]

ℓ_{ef} point side penetration length [mm]
 a_1 spacing parallel to the grain [mm]
 $a_{1,c}$ end distance [mm]

Reinforcing screws for compression shall be arranged according to Annex C.

Reinforcing screws for wood-based panels are not covered by this European Technical Assessment.

The characteristic buckling capacity $F_{ki,Rk}$ shall be calculated from:

$$F_{ki,Rk} = \kappa_c \cdot N_{pl,k} \quad [N]$$

where

$$\kappa_c = \begin{cases} 1 & \text{for } \bar{\lambda}_k \leq 0,2 \\ \frac{1}{k + \sqrt{k^2 - \bar{\lambda}_k^2}} & \text{for } \bar{\lambda}_k > 0,2 \end{cases}$$

$$k = 0,5 \cdot \left[1 + 0,49 \cdot (\bar{\lambda}_k - 0,2) + \bar{\lambda}_k^2 \right]$$

The relative slenderness ratio shall be calculated from:

$$\bar{\lambda}_k = \sqrt{\frac{N_{pl,k}}{N_{ki,k}}}$$

where

$$N_{pl,k} = \pi \cdot \frac{d_1^2}{4} \cdot f_{y,k} \quad [N]$$

is the characteristic value for the axial capacity in case of plastic analysis referred to the inner thread cross section.

Characteristic yield strength of screws from carbon steel:
 $f_{y,k} = 1000 \quad [N/mm^2]$

Characteristic ideal elastic buckling load:

$$N_{ki,k} = \sqrt{c_h \cdot E_s \cdot I_s} \quad [N]$$

Elastic foundation of the screw:

$$c_h = (0,19 + 0,012 \cdot d) \cdot \rho_k \cdot \left(\frac{\alpha}{180^\circ} + 0,5 \right) \quad [N/mm^2]$$

Modulus of elasticity:

$$E_s = 210000 \quad [N/mm^2]$$

Second moment of area:

$$I_s = \frac{\pi}{64} \cdot d_1^4 \quad [mm^4]$$

d_1 = inner thread diameter [mm]

Note: When determining design values of the compressive capacity it should be considered that $f_{ax,d}$ is to be calculated using k_{mod} and γ_M for timber according to EN 1995 while $N_{pl,d}$ is calculated using $\gamma_{M,0}$ for steel according to EN 1993.

Thermal insulation material on top of rafters

Rotho Blaas screws with an outer thread diameter of at least $d = 6$ mm may be used for the fixing of Thermal insulation material on top of rafters.

The thickness of the insulation shall not exceed 300 mm. The rafter insulation must be placed on top of solid timber or glued laminated timber rafters or cross-laminated timber members and be fixed by battens arranged parallel to the rafters or by wood-based panels on top of the insulation layer. The insulation of vertical facades is also covered by the rules given here.

Screws must be screwed in the rafter through the battens or panels and the insulation without pre-drilling in one sequence.

The angle α between the screw axis and the grain direction of the rafter should be between 30° and 90° .

The battens must be from solid timber (softwood) according to EN 338:2003-04. The minimum thickness t and the minimum width b of the battens is given as follows:

Screws $d = 6$ mm:	$b_{min} = 50$ mm	$t_{min} = 30$ mm
Screws $d = 7$ mm:	$b_{min} = 50$ mm	$t_{min} = 30$ mm
Screws $d = 8$ mm:	$b_{min} = 50$ mm	$t_{min} = 30$ mm
Screws $d = 9$ mm:	$b_{min} = 60$ mm	$t_{min} = 40$ mm
Screws $d = 10$ mm:	$b_{min} = 60$ mm	$t_{min} = 40$ mm
Screws $d = 11$ mm:	$b_{min} = 80$ mm	$t_{min} = 60$ mm
Screws $d = 12$ mm:	$b_{min} = 100$ mm	$t_{min} = 80$ mm

Alternatively to the battens, boards with a minimum thickness of 20 mm from plywood according to EN 636, particle board according to EN 312, oriented strand board OSB/3 and OSB/4 according to EN 300, solid wood panels according to EN 13353 or to ETA or national provision that apply at the installation site or cross laminated timber according to ETA may be used.

The rafter consists of solid timber (softwood) according to EN 338, glued laminated timber according to EN 14081, cross-laminated timber, and laminated veneer lumber according to EN 14374 or to ETA or similar glued members according to ETA.

The insulation must comply with a European Technical specification.

The insulation must have a minimum compressive stress of $\sigma_{10\%} = 0,05$ N/mm² at 10 % deformation according to EN 826:1996-05.

The analysis of the fixing of the insulation and battens or boards, respectively, may be carried out using the static model in Annex D. The battens or boards, respectively, must have sufficient strength and stiffness. The maximum design value of the compressive stress between the battens

or boards, respectively, and the insulation shall not exceed $1,1 \cdot \sigma_{10\%}$.

The characteristic axial capacity of the “HBS”, “HBS+”, „TBS”, “KKF“ and “SCI” screws for rafter or facade insulation shall be calculated from:

$$F_{ax,\alpha,Rd} = \min \left\{ \frac{f_{ax,d} \cdot d \cdot \ell_{ef} \cdot k_1 \cdot k_2}{1,2 \cdot \cos^2 \alpha + \sin^2 \alpha} \cdot \left(\frac{\rho_k}{350} \right)^{0,8}; f_{head,d} \cdot d_h^2 \cdot \left(\frac{\rho_k}{350} \right)^{0,8}; \frac{f_{tens,k}}{\gamma_{M2}} \right\}$$

The characteristic axial capacity of the “DGZ”, “VGS“ or “VGZ” screws for rafter or facade insulation shall be calculated from:

$$F_{ax,\alpha,Rd} = \min \left\{ \begin{array}{l} \frac{f_{ax,d} \cdot d \cdot \ell_{ef} \cdot k_1 \cdot k_2}{1,2 \cdot \cos^2 \alpha + \sin^2 \alpha} \cdot \left(\frac{\rho_k}{350} \right)^{0,8} \\ \max \left\{ f_{head,d} \cdot d_h^2; \frac{f_{ax,d} \cdot d \cdot \ell_{ef,b}}{1,2 \cdot \cos^2 \alpha + \sin^2 \alpha} \right\} \cdot \left(\frac{\rho_k}{350} \right)^{0,8} \\ \frac{f_{tens,k}}{\gamma_{M2}} \end{array} \right\}$$

where

$F_{ax,\alpha,Rd}$	Design value of the axial capacity of the connection at an angle α to the grain [N]
$f_{ax,d}$	Design value of the axial withdrawal parameter of the threaded part of the screw [N/mm ²]
d	Outer thread diameter [mm]
ℓ_{ef}	Point side penetration length of the threaded part according to EN 1995-1-1:2008 [mm]
$\ell_{ef,b}$	Length of the threaded part in the batten [mm]
α	Angle between grain and screw axis ($\alpha \geq 30^\circ$)
γ_{M2}	Partial factor according to EN 1993-1-1 or to the particular national annex
k_1	$\min \{1; 200/t_{HI}\}$
k_2	$\min \{1; \sigma_{10\%}/0,12\}$
t_{HI}	Thickness of the Thermal insulation material [mm]
$\sigma_{10\%}$	Compressive stress of the Thermal insulation material under 10 % deformation [N/mm ²] $\sigma_{10\%} \geq 0,05 \text{ N/mm}^2$
$f_{head,d}$	Design value of the head pull-through capacity [N/mm ²]
d_h	Outer diameter of the screw head [mm]
ρ_k	Characteristic density of the batten or rafter, respectively [kg/m ³]

Friction forces shall not be considered for the design of the characteristic axial capacity of the screws.

The anchorage of wind suction forces as well as the bending stresses of the battens or the boards, respectively, shall be considered in design. Additional screws perpendicular to the grain of the rafter (angle $\alpha = 90^\circ$) may be arranged if necessary.

The maximum screw spacing is $e_s = 1,75 \text{ m}$.

Screws for the anchorage of rafter insulation shall be arranged according to Annex D (thermal insulation on rafters with parallel inclined screws or with alternatively inclined screws).

3.11 Aspects related to the performance of the product

3.11.1 Corrosion protection in service class 1, 2 and 3.

The Rotho Blaas screws are produced from steel wire. Screws made from steel are electrogalvanised and yellow or blue chromate. The thickness of the zinc coating is minimum 5 μm .

Steel no. 1.4006, 1.4401 and 1.4567 is used for screws made from stainless steel.

3.12 General aspects related to the intended use of the product

The screws are manufactured in accordance with the provisions of the ETA using the automated manufacturing process and laid down in the technical documentation.

The installation shall be carried out in accordance with Eurocode 5 or an appropriate national code unless otherwise is defined in the following. Instructions from Rotho Blaas SRL should be considered for installation.

The screws are used for connections in load bearing timber structures between members of solid timber (softwood), glued laminated timber, cross-laminated timber, laminated veneer lumber, similar glued members, wood-based panels or steel members.

The screws may be used for connections in load bearing timber structures with structural members according to an associated ETA, if according to the associated ETA of the structural member a connection in load bearing timber structures with screws according to a ETA is allowed.

Rotho Blaas fully threaded “VGS” and “VGZ” screws are also used as tensile or compressive reinforcement perpendicular to the grain.

Furthermore the screws with diameters of at least 6 mm may also be used for the fixing of insulation on top of rafters.

A minimum of two screws should be used for connections in load bearing timber structures.

The minimum penetration depth in structural members made of solid, glued or cross-laminated timber is $4 \cdot d$.

Wood-based panels and steel plates should only be arranged on the side of the screw head. The minimum thickness of wood-based panels should be $1,2 \cdot d$. Furthermore the minimum thickness for following wood-based panels should be:

- Plywood, Fibreboards: 6 mm
- Particleboards, OSB, Cement Particleboards: 8 mm
- Solid wood panels: 12 mm

For structural members according to ETA's the terms of the ETA's must be considered.

If screws with an outer thread diameter $d \geq 8$ mm are used in load bearing timber structures, the structural solid or glued laminated timber, laminated veneer lumber and similar glued members must be from spruce, pine or fir. This does not apply for screws in pre-drilled holes.

The minimum angle between the screw axis and the grain direction is $\alpha = 30^\circ$.

The screws shall be driven into the wood with or without pre-drilling. The maximum pre-drilling diameter is the inner thread diameter. The hole diameter in steel members must be predrilled with a suitable diameter. Hard wood substrates shall always be pre-drilled.

Only the equipment prescribed by Rotho Blaas SRL shall be used for driving the screws.

In connections with screws with countersunk head according to Annex A the head must be flush with the surface of the connected structural member. A deeper countersink is not allowed.

For structural timber members, minimum spacing and distances for screws in predrilled holes are given in EN 1995-1-1:2008 (Eurocode 5) clause 8.3.1.2 and table 8.2 as for nails in predrilled holes. Here, the outer thread diameter d must be considered.

For screws in non-predrilled holes, minimum spacing and distances are given in EN 1995-1-1:2008 (Eurocode 5) clause 8.3.1.2 and table 8.2 as for nails in non-predrilled holes.

Minimum distances and spacing for "KKT" screws in non-predrilled holes in members with a minimum thickness $t = 4 \cdot d$ and a minimum width of $12 \cdot d$ or 60 mm, whichever is the greater, may be taken as:

Spacing a_1 parallel to the grain	$a_1 = 8 \cdot d$
Spacing a_2 perpendicular to the grain	$a_2 = 4 \cdot d$
Loaded end distance:	$a_{3,t} = 12 \cdot d$
Unloaded end distance:	$a_{3,c} = 5 \cdot d$
Loaded edge distance:	$a_{4,t} = 5 \cdot d$
Unloaded edge distance:	$a_{4,c} = 4 \cdot d$

For Douglas fir members minimum spacing and distances parallel to the grain shall be increased by 50%.

Minimum distances from loaded or unloaded ends must be $15 \cdot d$ for screws in non-predrilled holes with outer thread diameter $d \geq 8$ mm and timber thickness $t < 5 \cdot d$.

Minimum distances from the unloaded edge perpendicular to the grain may be reduced to $3 \cdot d$ also for timber thickness $t < 5 \cdot d$, if the spacing parallel to the grain and the end distance is at least $25 \cdot d$.

Minimum distances and spacing for exclusively axially loaded screws in predrilled and non-predrilled holes in members with a minimum thickness $t = 12 \cdot d$ and a minimum width of $8 \cdot d$ or 60 mm, whichever is the greater, may be taken as:

Spacing a_1 parallel to the grain	$a_1 = 5 \cdot d$
Spacing a_2 perpendicular to the grain	$a_2 = 5 \cdot d$
Distance $a_{1,CG}$ from centre of the screw-part in timber to the end grain	$a_{1,CG} = 10 \cdot d$
Distance $a_{2,CG}$ from centre of the screw-part in timber to the edge	$a_{2,CG} = 4 \cdot d$

Spacing a_2 perpendicular to the grain may be reduced from $5 \cdot d$ to $2,5 \cdot d$, if the condition $a_1 \cdot a_2 \geq 25 \cdot d^2$ is fulfilled.

For a crossed screw couple the minimum spacing between the crossing screws is $1,5 \cdot d$.

Minimum thickness for structural members is $t = 30$ mm for screws with outer thread diameter $d = 8$ mm, $t = 40$ mm for screws with outer thread diameter $d = 10$ mm, $t = 60$ mm for screws with outer thread diameter $d = 11$ mm, and $t = 80$ mm for screws with outer thread diameter $d = 12$ mm.

Unless specified otherwise in the technical specification (ETA or hEN) of cross laminated timber, minimum distances and spacing for screws in the wide face of cross laminated timber members with a minimum thickness $t = 10 \cdot d$ may be taken as (see Annex B):

Spacing a_1 parallel to the grain	$a_1 = 4 \cdot d$
Spacing a_2 perpendicular to the grain	$a_2 = 2,5 \cdot d$
Distance $a_{3,c}$ from centre of the screw-part in timber to the unloaded end grain	$a_{3,c} = 6 \cdot d$
Distance $a_{3,t}$ from centre of the screw-part in timber to the loaded end grain	$a_{3,t} = 6 \cdot d$
Distance $a_{4,c}$ from centre of the screw-part in timber to the unloaded edge	$a_{4,c} = 2,5 \cdot d$
Distance $a_{4,t}$ from centre of the screw-part in timber to the loaded edge	$a_{4,t} = 6 \cdot d$

Unless specified otherwise in the technical specification (ETA or hEN) of cross laminated timber, minimum distances and spacing for screws in the edge surface of cross laminated timber members with a minimum thickness $t = 10 \cdot d$ and a minimum penetration depth perpendicular to the edge surface of $10 \cdot d$ may be taken as (see Annex B):

Spacing a_1 parallel to the CLT plane	$a_1 = 10 \cdot d$
Spacing a_2 perpendicular to the CLT plane	$a_2 = 4 \cdot d$
Distance $a_{3,c}$ from centre of the screw-part in	

timber to the unloaded end	$a_{3,c} = 7 \cdot d$
Distance $a_{3,t}$ from centre of the screw-part in timber to the loaded end	$a_{3,t} = 12 \cdot d$
Distance $a_{4,c}$ from centre of the screw-part in timber to the unloaded edge	$a_{4,c} = 3 \cdot d$
Distance $a_{4,t}$ from centre of the screw-part in timber to the loaded edge	$a_{4,t} = 6 \cdot d$

4 Attestation and verification of constancy of performance (AVCP)

4.1 AVCP system

According to the decision 97/176/EC of the European Commission¹, as amended, the system(s) of assessment and verification of constancy of performance (see Annex V to Regulation (EU) No 305/2011) is 3.

5 Technical details necessary for the implementation of the AVCP system, as foreseen in the applicable EAD

Technical details necessary for the implementation of the AVCP system are laid down in the control plan deposited at ETA-Danmark.

Issued in Copenhagen on 2016-04-07 by



Thomas Bruun
Managing Director, ETA-Danmark

Annex A Drawings of Rotho Blaas Screws

Rotho Blaas Screws "HBS"

d₁ [mm]	3.00 ± 0.08	3.50 ± 0.09	4.00 ± 0.10	4.50 ± 0.11	5.00 ± 0.12	6.00 ± 0.15	8.00 ± 0.20	10.00 ± 0.25	12.00 ± 0.30
d₂ [mm]	2.00 ± 0.05	2.25 ± 0.05	2.55 ± 0.06	2.80 ± 0.07	3.40 ± 0.09	3.95 ± 0.10	5.40 ± 0.13	6.40 ± 0.16	6.80 ± 0.17
d_s [mm]	2.16 ± 0.05	2.45 ± 0.06	2.75 ± 0.07	3.15 ± 0.08	3.65 ± 0.09	4.30 ± 0.11	5.80 ± 0.14	7.00 ± 0.18	8.00 ± 0.20
d_k [mm]	6.00 ± 0.15	7.00 ± 0.18	8.00 ± 0.20	9.00 ± 0.23	10.00 ± 0.25	12.00 ± 0.30	14.50 ± 0.36	18.25 ± 0.46	20.75 ± 0.52

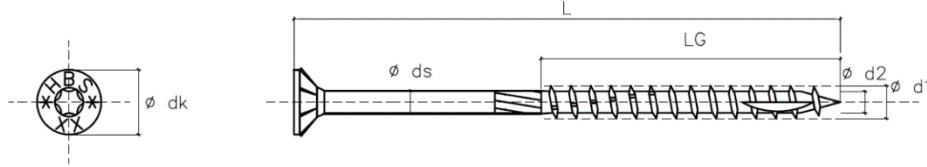

Shank Ribs Optional

Tolerance (L_s and L_G): + 2.00 mm - 1.00 mm / All specification in [mm] / Intermediate length (L) and thread length (L_G) are possible.

d₁ 3.00 mm		d₁ 3.50 mm		d₁ 4.00 mm		d₁ 4.50 mm		d₁ 5.00 mm		d₁ 6.00 mm		d₁ 8.00 mm		d₁ 10.00 mm		d₁ 12.00 mm	
L	L_G	L	L_G	L	L_G	L	L_G	L	L_G	L	L_G	L	L_G	L	L_G	L	L_G
[mm]	[mm]	[mm]	[mm]	[mm]	[mm]	[mm]	[mm]	[mm]	[mm]	[mm]	[mm]	[mm]	[mm]	[mm]	[mm]	[mm]	[mm]
20	15	20	14	25	20	25	20	40	20	40	35	40	32	60	52	160	80
25	20	25	14	30	16	30	25	45	24	50	35	60	52	80	52	200	80
30	25	25	20	30	18	35	18	50	24	50	45	80	52	90	52	200	100
35	30	30	18	30	25	35	24	50	30	60	30	90	52	100	52	220	80
40	35	30	25	35	16	40	24	60	30	60	35	100	52	120	52	220	100
		35	18	35	18	45	24	60	35	70	30	100	60	120	60	240	80
		40	18	40	24	45	30	70	35	70	40	100	80	120	80	240	100
		45	24	45	24	50	24	70	40	80	40	120	52	140	52	260	80
		50	24	45	30	50	30	80	40	80	50	120	60	140	60	260	100
				50	24	60	30	80	50	90	40	120	80	140	80	280	80
				50	30	60	35	90	45	90	50	140	52	160	80	280	100
				60	30	70	35	90	55	90	55	140	60	180	80	300	80
				60	35	70	40	100	50	100	50	140	80	180	90	300	100
				70	35	80	40	100	60	100	60	160	80	200	80	300	120
				70	40			110	50	110	50	160	90	200	100	320	80
				80	40			110	55	110	60	160	100	220	80	320	100
								110	60	120	50	180	80	220	100	320	120
								120	50	120	60	180	90	240	80	340	80
								120	60	120	75	180	100	240	100	340	100
										130	50	200	80	260	80	340	120
										130	60	200	100	260	100	360	80
										130	75	220	80	280	80	360	100
										140	75	220	100	280	100	360	120
										140	80	240	80	300	80	380	80
										150	75	240	100	300	100	380	100
										150	80	260	80	300	120	380	120
										160	75	260	100	320	80	400	80
										160	90	280	80	320	100	400	100
										180	75	280	100	320	120	400	120
										180	100	300	80	340	80	440	100
										200	75	300	100	340	100	440	120
										200	100	300	120	340	120	480	100
										220	75	320	80	360	80	480	120
										220	100	320	100	360	100	500	100
										240	75	320	120	360	120	500	120
										240	100	340	80	380	80	520	100
										260	75	340	100	380	100	520	120
										260	100	340	120	380	120	540	100
										280	75	360	80	400	80	540	120
										280	100	360	100	400	100	550	100
										300	75	360	120	400	120	550	120
										300	100	380	80	420	80	560	100
												380	100	420	100	560	120
												380	120	420	120	600	100
												400	80	440	100	600	120
												400	100	440	120		
												400	120	450	100		
												420	80	450	120		
												420	100	460	100		
												420	120	460	120		
												440	100	480	100		
												440	120	480	120		
												450	100	500	100		
												450	120	500	120		
												460	100				
												460	120				
												480	100				
												480	120				
												500	100				
												500	120				

Rotho Blaas Screws “SCH”

d₁ [mm]	3.00 ± 0.08	3.50 ± 0.09	4.00 ± 0.10	4.50 ± 0.11	5.00 ± 0.12	6.00 ± 0.15	8.00 ± 0.20	10.00 ± 0.25	12.00 ± 0.30
d₂ [mm]	2.00 ± 0.05	2.25 ± 0.05	2.55 ± 0.06	2.80 ± 0.07	3.40 ± 0.09	3.95 ± 0.10	5.40 ± 0.13	6.40 ± 0.16	6.80 ± 0.17
d_s [mm]	2.16 ± 0.05	2.45 ± 0.06	2.75 ± 0.07	3.15 ± 0.08	3.65 ± 0.09	4.30 ± 0.11	5.80 ± 0.14	7.00 ± 0.18	8.00 ± 0.20
d_k [mm]	6.00 ± 0.15	7.00 ± 0.18	8.00 ± 0.20	9.00 ± 0.23	10.00 ± 0.25	12.00 ± 0.30	14.50 ± 0.36	18.25 ± 0.46	20.75 ± 0.52

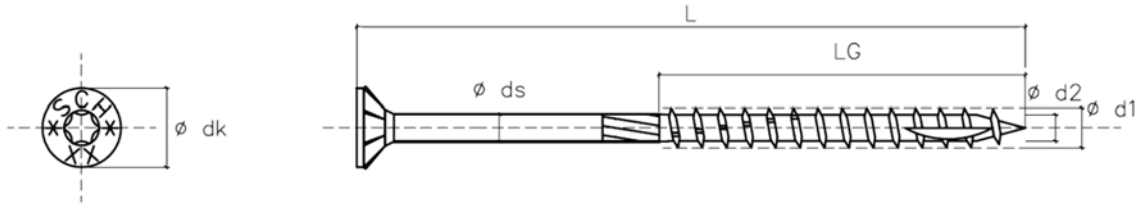

Shank Ribs and Carving Optional

d ₁ 3.00 mm		d ₁ 3.50 mm		d ₁ 4.00 mm		d ₁ 4.50 mm		d ₁ 5.00 mm		d ₁ 6.00 mm		d ₁ 8.00 mm		d ₁ 10.00 mm		d ₁ 12.00 mm	
L [mm]	L _G [mm]	L [mm]	L _G [mm]	L [mm]	L _G [mm]	L [mm]	L _G [mm]	L [mm]	L _G [mm]	L [mm]	L _G [mm]	L [mm]	L _G [mm]	L [mm]	L _G [mm]	L [mm]	L _G [mm]
20	15	20	14	25	20	25	20	40	20	40	35	40	32	60	52	160	80
25	20	25	14	30	16	30	25	45	24	50	35	60	52	80	52	200	80
30	25	25	20	30	18	35	18	50	24	50	45	80	52	90	52	200	100
35	30	30	18	30	25	35	24	50	30	60	30	90	52	100	52	220	80
40	35	30	25	35	16	40	24	60	30	60	35	100	52	120	52	220	100
		35	18	35	18	45	24	60	35	70	30	100	60	120	60	240	80
		40	18	40	24	45	30	70	35	70	40	100	80	120	80	240	100
		45	24	45	24	50	24	70	40	80	40	120	52	140	52	260	80
		50	24	45	30	50	30	80	40	80	50	120	60	140	60	260	100
				50	24	60	30	80	50	90	40	120	80	140	80	280	80
				50	30	60	35	90	45	90	50	140	52	160	80	280	100
				60	30	70	35	90	55	90	55	140	60	180	80	300	80
				60	35	70	40	100	50	100	50	140	80	180	90	300	100
				70	35	80	40	100	60	100	60	160	80	200	80	300	120
				70	40			110	50	110	50	160	90	200	100	320	80
				80	40			110	55	110	60	160	100	220	80	320	100
								110	60	120	50	180	80	220	100	320	120
								120	50	120	60	180	90	240	80	340	80
								120	60	120	75	180	100	240	100	340	100
										130	50	200	80	260	80	340	120
										130	60	200	100	260	100	360	80
										130	75	220	80	280	80	360	100
										140	75	220	100	280	100	360	120
										140	80	240	80	300	80	380	80
										150	75	240	100	300	100	380	100
										150	80	260	80	300	120	380	120
										160	75	260	100	320	80	400	80
										160	90	280	80	320	100	400	100
										180	75	280	100	320	120	400	120
										180	100	300	80	340	80	440	100
										200	75	300	100	340	100	440	120
										200	100	300	120	340	120	480	100
										220	75	320	80	360	80	480	120
										220	100	320	100	360	100	500	100
										240	75	320	120	360	120	500	120
										240	100	340	80	380	80	520	100
										260	75	340	100	380	100	520	120
										260	100	340	120	380	120	540	100
										280	75	360	80	400	80	540	120
										280	100	360	100	400	100	550	100
										300	75	360	120	400	120	550	120
										300	100	380	80	420	80	560	100
												380	100	420	100	560	120
												380	120	420	120	600	100
												400	80	440	100	600	120
												400	100	440	120		
												400	120	450	100		
												420	80	450	120		
												420	100	460	100		
												420	120	460	120		
												440	100	480	100		
												440	120	480	120		
												450	100	500	100		
												450	120	500	120		
												460	100				
												460	120				
												480	100				
												480	120				
												500	100				
												500	120				

Tolerance (L and L_G): + 2.00 mm - 1.00 mm / All specification in [mm] / Intermediate length (L) and thread length (L_G) are possible.

Rotho Blaas Screws “PSC” or “HTP”

d₁ [mm]	3.00 ± 0.08	3.50 ± 0.09	4.00 ± 0.10	4.50 ± 0.11	5.00 ± 0.12	6.00 ± 0.15	8.00 ± 0.20
d₂ [mm]	2.00 ± 0.05	2.25 ± 0.05	2.55 ± 0.06	2.80 ± 0.07	3.40 ± 0.09	3.95 ± 0.10	5.40 ± 0.13
d_s [mm]	2.16 ± 0.05	2.45 ± 0.06	2.75 ± 0.07	3.15 ± 0.08	3.65 ± 0.09	4.30 ± 0.11	5.80 ± 0.14
d_k [mm]	6.00 ± 0.15	7.00 ± 0.18	8.00 ± 0.20	9.00 ± 0.23	10.00 ± 0.25	12.00 ± 0.30	14.50 ± 0.36

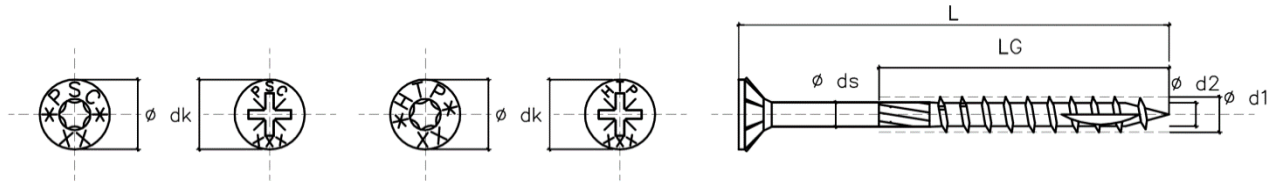

Shank Ribs and Carving Optional

d₁ 3.00 mm		d₁ 3.50 mm		d₁ 4.00 mm		d₁ 4.50 mm		d₁ 5.00 mm		d₁ 6.00 mm		d₁ 8.00 mm	
L	L_G	L	L_G	L	L_G	L	L_G	L	L_G	L	L_G	L	L_G
[mm]	[mm]	[mm]	[mm]	[mm]	[mm]	[mm]	[mm]	[mm]	[mm]	[mm]	[mm]	[mm]	[mm]
20	15	20	14	25	20	25	20	40	20	40	35	40	32
25	20	25	14	30	16	30	25	45	24	50	35	60	52
30	25	25	20	30	18	35	18	50	24	50	45	80	52
35	30	30	18	30	25	35	24	50	30	60	30	90	52
40	35	30	25	35	16	40	24	60	30	60	35	100	52
		35	18	35	18	45	24	60	35	70	30	100	60
		40	18	40	24	45	30	70	35	70	40	100	80
		45	24	45	24	50	24	70	40	80	40	120	52
		50	24	45	30	50	30	80	40	80	50	120	60
				50	24	60	30	80	50	90	40	120	80
				50	30	60	35	90	45	90	50	140	52
				60	30	70	35	90	55	90	55	140	60
				60	35	70	40	100	50	100	50	140	80
				70	35	80	40	100	60	100	60	160	80
				70	40			110	50	110	50	160	90
				80	40			110	55	110	60	160	100
								110	60	120	50	180	80
								120	50	120	60	180	90
								120	60	120	75	180	100
										130	50	200	80
										130	60	200	100
										130	75	220	80
										140	75	220	100
										140	80	240	80
										150	75	240	100
										150	80	260	80
										160	75	260	100
										160	90	280	80
										180	75	280	100
										180	100	300	80
										200	75	300	100
										200	100	300	120
										220	75	320	80
										220	100	320	100
										240	75	320	120
										240	100	340	80
										260	75	340	100
										260	100	340	120
										280	75	360	80
										280	100	360	100
										300	75	360	120
										300	100	380	80
												380	100
												380	120
												400	80
												400	100
												400	120
												420	80
												420	100
												420	120
												440	100
												440	120
												450	100
												450	120
												460	100
												460	120
												480	100
												480	120
												500	100
												500	120

Tolerance (L and L_G): + 2.00 mm - 1.00 mm / All specification in [mm] / Intermediate length (L) and thread length (L_G) are possible.

Rotho Blaas Screws “GHS”

d₁ [mm]	3.00 ± 0.08	3.50 ± 0.09	4.00 ± 0.10	4.50 ± 0.11	5.00 ± 0.12	6.00 ± 0.15	8.00 ± 0.20	10.00 ± 0.25	12.00 ± 0.30
d₂ [mm]	2.00 ± 0.05	2.25 ± 0.05	2.55 ± 0.06	2.80 ± 0.07	3.40 ± 0.09	3.95 ± 0.10	5.40 ± 0.13	6.40 ± 0.16	6.80 ± 0.17
d_s [mm]	2.16 ± 0.05	2.45 ± 0.06	2.75 ± 0.07	3.15 ± 0.08	3.65 ± 0.09	4.30 ± 0.11	5.80 ± 0.14	7.00 ± 0.18	8.00 ± 0.20
d_k [mm]	6.00 ± 0.15	7.00 ± 0.18	8.00 ± 0.20	9.00 ± 0.23	10.00 ± 0.25	12.00 ± 0.30	14.50 ± 0.36	18.25 ± 0.46	20.75 ± 0.52

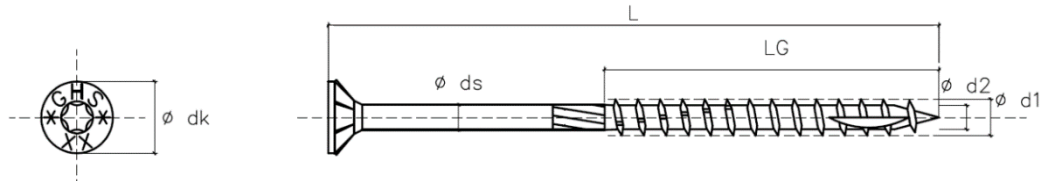

Shank Ribs Optional

d₁ 3.00 mm		d₁ 3.50 mm		d₁ 4.00 mm		d₁ 4.50 mm		d₁ 5.00 mm		d₁ 6.00 mm		d₁ 8.00 mm		d₁ 10.00 mm		d₁ 12.00	
L	L_G	L	L_G	L	L_G	L	L_G	L	L_G	L	L_G	L	L_G	L	L_G	L	L_G
[mm]	[mm]	[mm]	[mm]	[mm]	[mm]	[mm]	[mm]	[mm]	[mm]	[mm]	[mm]	[mm]	[mm]	[mm]	[mm]	[mm]	[mm]
20	15	20	14	25	20	25	20	40	20	40	35	40	32	60	52	160	80
25	20	25	14	30	16	30	25	45	24	50	35	60	52	80	52	200	80
30	25	25	20	30	18	35	18	50	24	50	45	80	52	90	52	200	100
35	30	30	18	30	25	35	24	50	30	60	30	90	52	100	52	220	80
40	35	30	25	35	16	40	24	60	30	60	35	100	52	120	52	220	100
		35	18	35	18	45	24	60	35	70	30	100	60	120	60	240	80
		40	18	40	24	45	30	70	35	70	40	100	80	120	80	240	100
		45	24	45	24	50	24	70	40	80	40	120	52	140	52	260	80
		50	24	45	30	50	30	80	40	80	50	120	60	140	60	260	100
				50	24	60	30	80	50	90	40	120	80	140	80	280	80
				50	30	60	35	90	45	90	50	140	52	160	80	280	100
				60	30	70	35	90	55	90	55	140	60	180	80	300	80
				60	35	70	40	100	50	100	50	140	80	180	90	300	100
				70	35	80	40	100	60	100	60	160	80	200	80	300	120
				70	40			110	50	110	50	160	90	200	100	320	80
				80	40			110	55	110	60	160	100	220	80	320	100
								110	60	120	50	180	80	220	100	320	120
								120	50	120	60	180	90	240	80	340	80
								120	60	120	75	180	100	240	100	340	100
										130	50	200	80	260	80	340	120
										130	60	200	100	260	100	360	80
										130	75	220	80	280	80	360	100
										140	75	220	100	280	100	360	120
										140	80	240	80	300	80	380	80
										150	75	240	100	300	100	380	100
										150	80	260	80	300	120	380	120
										160	75	260	100	320	80	400	80
										160	90	280	80	320	100	400	100
										180	75	280	100	320	120	400	120
										180	100	300	80	340	80	440	100
										200	75	300	100	340	100	440	120
										200	100	300	120	340	120	480	100
										220	75	320	80	360	80	480	120
										220	100	320	100	360	100	500	100
										240	75	320	120	360	120	500	120
										240	100	340	80	380	80	520	100
										260	75	340	100	380	100	520	120
										260	100	340	120	380	120	540	100
										280	75	360	80	400	80	540	120
										280	100	360	100	400	100	550	100
										300	75	360	120	400	120	550	120
										300	100	380	80	420	80	560	100
												380	100	420	100	560	120
												380	120	420	120	600	100
												400	80	440	100	600	120
												400	100	440	120		
												400	120	450	100		
												420	80	450	120		
												420	100	460	100		
												420	120	460	120		
												440	100	480	100		
												440	120	480	120		
												450	100	500	100		
												450	120	500	120		
												460	100				
												460	120				
												480	100				
												480	120				
												500	100				
												500	120				

Tolerance (L and L_G): + 2.00 mm - 1.00 mm / All specification in [mm] / Intermediate length (L) and thread length (L_G) are possible.

Rotho Blaas Screws “SENK” or “SNK” or “HTS”

d₁ [mm]	3.00 ± 0.08	3.50 ± 0.09	4.00 ± 0.10	4.50 ± 0.11	5.00 ± 0.12	6.00 ± 0.15	8.00 ± 0.20	10.00 ± 0.25	12.00 ± 0.30
d₂ [mm]	2.00 ± 0.05	2.25 ± 0.05	2.55 ± 0.06	2.80 ± 0.07	3.40 ± 0.09	3.95 ± 0.10	5.40 ± 0.13	6.40 ± 0.16	6.80 ± 0.17
d_s [mm]	2.16 ± 0.05	2.45 ± 0.06	2.75 ± 0.07	3.15 ± 0.08	3.65 ± 0.09	4.30 ± 0.11	5.80 ± 0.14	7.00 ± 0.18	8.00 ± 0.20
d_k [mm]	6.00 ± 0.15	7.00 ± 0.18	8.00 ± 0.20	9.00 ± 0.23	10.00 ± 0.25	12.00 ± 0.30	14.50 ± 0.36	18.25 ± 0.46	20.75 ± 0.52

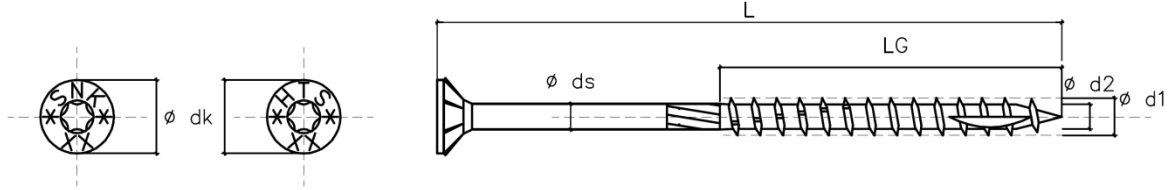

Shank Ribs and Carving Optional

d ₁ 3.00 mm		d ₁ 3.50 mm		d ₁ 4.00 mm		d ₁ 4.50 mm		d ₁ 5.00 mm		d ₁ 6.00 mm		d ₁ 8.00 mm		d ₁ 10.00 mm		d ₁ 12.00 mm	
L [mm]	L _G [mm]	L [mm]	L _G [mm]	L [mm]	L _G [mm]	L [mm]	L _G [mm]	L [mm]	L _G [mm]	L [mm]	L _G [mm]	L [mm]	L _G [mm]	L [mm]	L _G [mm]	L [mm]	L _G [mm]
20	15	20	14	25	20	25	20	40	20	40	35	40	32	60	52	160	80
25	20	25	14	30	16	30	25	45	24	50	35	60	52	80	52	200	80
30	25	25	20	30	18	35	18	50	24	50	45	80	52	90	52	200	100
35	30	30	18	30	25	35	24	50	30	60	30	90	52	100	52	220	80
40	35	30	25	35	16	40	24	60	30	60	35	100	52	120	52	220	100
		35	18	35	18	45	24	60	35	70	30	100	60	120	60	240	80
		40	18	40	24	45	30	70	35	70	40	100	80	120	80	240	100
		45	24	45	24	50	24	70	40	80	40	120	52	140	52	260	80
		50	24	45	30	50	30	80	40	80	50	120	60	140	60	260	100
				50	24	60	30	80	50	90	40	120	80	140	80	280	80
				50	30	60	35	90	45	90	50	140	52	160	80	280	100
				60	30	70	35	90	55	90	55	140	60	180	80	300	80
				60	35	70	40	100	50	100	50	140	80	180	90	300	100
				70	35	80	40	100	60	100	60	160	80	200	80	300	120
				70	40			110	50	110	50	160	90	200	100	320	80
				80	40			110	55	110	60	160	100	220	80	320	100
								110	60	120	50	180	80	220	100	320	120
								120	50	120	60	180	90	240	80	340	80
								120	60	120	75	180	100	240	100	340	100
										130	50	200	80	260	80	340	120
										130	60	200	100	260	100	360	80
										130	75	220	80	280	80	360	100
										140	75	220	100	280	100	360	120
										140	80	240	80	300	80	380	80
										150	75	240	100	300	100	380	100
										150	80	260	80	300	120	380	120
										160	75	260	100	320	80	400	80
										160	90	280	80	320	100	400	100
										180	75	280	100	320	120	400	120
										180	100	300	80	340	80	440	100
										200	75	300	100	340	100	440	120
										200	100	300	120	340	120	480	100
										220	75	320	80	360	80	480	120
										220	100	320	100	360	100	500	100
										240	75	320	120	360	120	500	120
										240	100	340	80	380	80	520	100
										260	75	340	100	380	100	520	120
										260	100	340	120	380	120	540	100
										280	75	360	80	400	80	540	120
										280	100	360	100	400	100	550	100
										300	75	360	120	400	120	550	120
										300	100	380	80	420	80	560	100
												380	100	420	100	560	120
												380	120	420	120	600	100
												400	80	440	100	600	120
												400	100	440	120		
												400	120	450	100		
												420	80	450	120		
												420	100	460	100		
												420	120	460	120		
												440	100	480	100		
												440	120	480	120		
												450	100	500	100		
												450	120	500	120		
												460	100				
												460	120				
												480	100				
												480	120				
												500	100				
												500	120				

Tolerance (L and L_G): + 2.00 mm - 1.00 mm / All specification in [mm] / Intermediate length (L) and thread length (L_G) are possible.

Rotho Blaas Screws “HBS+”

d₁ [mm]	4.00 ± 0.10	4.50 ± 0.11	5.00 ± 0.12	6.00 ± 0.15	8.00 ± 0.20	10.00 ± 0.25	12.00 ± 0.30
d₂ [mm]	2.55 ± 0.06	2.80 ± 0.07	3.40 ± 0.09	3.95 ± 0.10	5.40 ± 0.13	6.40 ± 0.16	6.80 ± 0.17
d_s [mm]	2.75 ± 0.07	3.15 ± 0.08	3.65 ± 0.09	4.30 ± 0.11	5.80 ± 0.14	7.00 ± 0.18	8.00 ± 0.20
d_k [mm]	8.00 ± 0.20	9.00 ± 0.23	10.00 ± 0.25	12.00 ± 0.30	14.50 ± 0.36	18.25 ± 0.46	20.75 ± 0.52

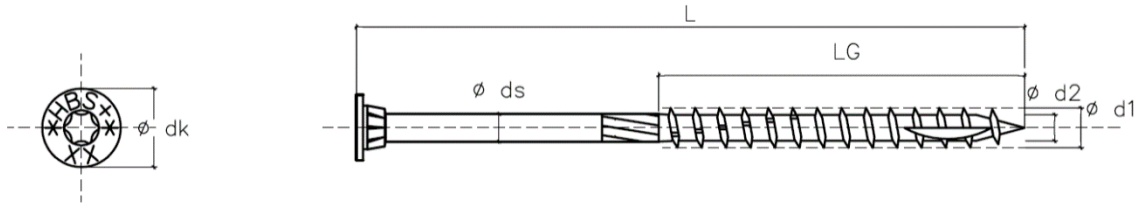

d₁ 4.00 mm		d₁ 4.50 mm		d₁ 5.00 mm		d₁ 6.00 mm		d₁ 8.00 mm		d₁ 10.00 mm		d₁ 12.00	
L	L_G	L	L_G	L	L_G	L	L_G	L	L_G	L	L_G	L	L_G
[mm]	[mm]	[mm]	[mm]	[mm]	[mm]	[mm]	[mm]	[mm]	[mm]	[mm]	[mm]	[mm]	[mm]
25	20	25	20	40	20	40	35	40	32	60	52	160	80
30	16	30	25	45	24	50	35	60	52	80	52	200	80
30	18	35	18	50	24	50	45	80	52	90	52	200	100
30	25	35	24	50	30	60	30	90	52	100	52	220	80
35	16	40	24	60	30	60	35	100	52	120	52	220	100
35	18	45	24	60	35	70	30	100	60	120	60	240	80
40	24	45	30	70	35	70	40	100	80	120	80	240	100
45	24	50	24	70	40	80	40	120	52	140	52	260	80
45	30	50	30	80	40	80	50	120	60	140	60	260	100
50	24	60	30	80	50	90	40	120	80	140	80	280	80
50	30	60	35	90	45	90	50	140	52	160	80	280	100
60	30	70	35	90	55	90	55	140	60	180	80	300	80
60	35	70	40	100	50	100	50	140	80	180	90	300	100
70	35	80	40	100	60	100	60	160	80	200	80	300	120
70	40			110	50	110	50	160	90	200	100	320	80
80	40			110	55	110	60	160	100	220	80	320	100
				110	60	120	50	180	80	220	100	320	120
				120	50	120	60	180	90	240	80	340	80
				120	60	120	75	180	100	240	100	340	100
						130	50	200	80	260	80	340	120
						130	60	200	100	260	100	360	80
						130	75	220	80	280	80	360	100
						140	75	220	100	280	100	360	120
						140	80	240	80	300	80	380	80
						150	75	240	100	300	100	380	100
						150	80	260	80	300	120	380	120
						160	75	260	100	320	80	400	80
						160	90	280	80	320	100	400	100
						180	75	280	100	320	120	400	120
						180	100	300	80	340	80	440	100
						200	75	300	100	340	100	440	120
						200	100	300	120	340	120	480	100
						220	75	320	80	360	80	480	120
						220	100	320	100	360	100	500	100
						240	75	320	120	360	120	500	120
						240	100	340	80	380	80	520	100
						260	75	340	100	380	100	520	120
						260	100	340	120	380	120	540	100
						280	75	360	80	400	80	540	120
						280	100	360	100	400	100	550	100
						300	75	360	120	400	120	550	120
						300	100	380	80	420	80	560	100
								380	100	420	100	560	120
								380	120	420	120	600	100
								400	80	440	100	600	120
								400	100	440	120		
								400	120	450	100		
								420	80	450	120		
								420	100	460	100		
								420	120	460	120		
								440	100	480	100		
								440	120	480	120		
								450	100	500	100		
								450	120	500	120		
								460	100				
								460	120				
								480	100				
								480	120				
								500	100				
								500	120				

Tolerance (L and L_G): + 2.00 mm - 1.00 mm / All specification in [mm] / Intermediate length (L) and thread length (L_G) are possible.

Rotho Blaas Screws “GHS+”

d₁ [mm]	4.00 ± 0.10	4.50 ± 0.11	5.00 ± 0.12	6.00 ± 0.15	8.00 ± 0.20	10.00 ± 0.25	12.00 ± 0.30
d₂ [mm]	2.55 ± 0.06	2.80 ± 0.07	3.40 ± 0.09	3.95 ± 0.10	5.40 ± 0.13	6.40 ± 0.16	6.80 ± 0.17
d_s [mm]	2.75 ± 0.07	3.15 ± 0.08	3.65 ± 0.09	4.30 ± 0.11	5.80 ± 0.14	7.00 ± 0.18	8.00 ± 0.20
d_k [mm]	8.00 ± 0.20	9.00 ± 0.23	10.00 ± 0.25	12.00 ± 0.30	14.50 ± 0.36	18.25 ± 0.46	20.75 ± 0.52

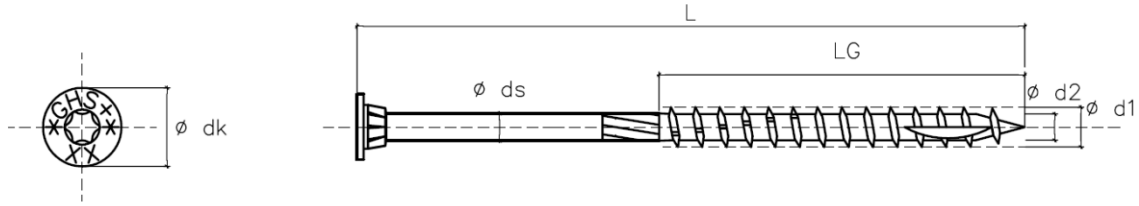

d₁ 4.00 mm		d₁ 4.50 mm		d₁ 5.00 mm		d₁ 6.00 mm		d₁ 8.00 mm		d₁ 10.00 mm		d₁ 12.00	
L [mm]	L_G [mm]	L [mm]	L_G [mm]	L [mm]	L_G [mm]	L [mm]	L_G [mm]	L [mm]	L_G [mm]	L [mm]	L_G [mm]	L [mm]	L_G [mm]
25	20	25	20	40	20	40	35	40	32	60	52	160	80
30	16	30	25	45	24	50	35	60	52	80	52	200	80
30	18	35	18	50	24	50	45	80	52	90	52	200	100
30	25	35	24	50	30	60	30	90	52	100	52	220	80
35	16	40	24	60	30	60	35	100	52	120	52	220	100
35	18	45	24	60	35	70	30	100	60	120	60	240	80
40	24	45	30	70	35	70	40	100	80	120	80	240	100
45	24	50	24	70	40	80	40	120	52	140	52	260	80
45	30	50	30	80	40	80	50	120	60	140	60	260	100
50	24	60	30	80	50	90	40	120	80	140	80	280	80
50	30	60	35	90	45	90	50	140	52	160	80	280	100
60	30	70	35	90	55	90	55	140	60	180	80	300	80
60	35	70	40	100	50	100	50	140	80	180	90	300	100
70	35	80	40	100	60	100	60	160	80	200	80	300	120
70	40			110	50	110	50	160	90	200	100	320	80
80	40			110	55	110	60	160	100	220	80	320	100
				110	60	120	50	180	80	220	100	320	120
				120	50	120	60	180	90	240	80	340	80
				120	60	120	75	180	100	240	100	340	100
						130	50	200	80	260	80	340	120
						130	60	200	100	260	100	360	80
						130	75	220	80	280	80	360	100
						140	75	220	100	280	100	360	120
						140	80	240	80	300	80	380	80
						150	75	240	100	300	100	380	100
						150	80	260	80	300	120	380	120
						160	75	260	100	320	80	400	80
						160	90	280	80	320	100	400	100
						180	75	280	100	320	120	400	120
						180	100	300	80	340	80	440	100
						200	75	300	100	340	100	440	120
						200	100	300	120	340	120	480	100
						220	75	320	80	360	80	480	120
						220	100	320	100	360	100	500	100
						240	75	320	120	360	120	500	120
						240	100	340	80	380	80	520	100
						260	75	340	100	380	100	520	120
						260	100	340	120	380	120	540	100
						280	75	360	80	400	80	540	120
						280	100	360	100	400	100	550	100
						300	75	360	120	400	120	550	120
						300	100	380	80	420	80	560	100
								380	100	420	100	560	120
								380	120	420	120	600	100
								400	80	440	100	600	120
								400	100	440	120		
								400	120	450	100		
								420	80	450	120		
								420	100	460	100		
								420	120	460	120		
								440	100	480	100		
								440	120	480	120		
								450	100	500	100		
								450	120	500	120		
								460	100				
								460	120				
								480	100				
								480	120				
								500	100				
								500	120				

Tolerance (L and L_G): + 2.00 mm - 1.00 mm / All specification in [mm] / Intermediate length (L) and thread length (L_G) are possible.

Rotho Blaas Screws “KEGEL” or “KGL” or “HTK”

d₁ [mm]	4.00 ± 0.10	4.50 ± 0.11	5.00 ± 0.12	6.00 ± 0.15	8.00 ± 0.20	10.00 ± 0.25	12.00 ± 0.30
d₂ [mm]	2.55 ± 0.06	2.80 ± 0.07	3.40 ± 0.09	3.95 ± 0.10	5.40 ± 0.13	6.40 ± 0.16	6.80 ± 0.17
d_s [mm]	2.75 ± 0.07	3.15 ± 0.08	3.65 ± 0.09	4.30 ± 0.11	5.80 ± 0.14	7.00 ± 0.18	8.00 ± 0.20
d_k [mm]	8.00 ± 0.20	9.00 ± 0.23	10.00 ± 0.25	12.00 ± 0.30	14.50 ± 0.36	18.25 ± 0.46	20.75 ± 0.52

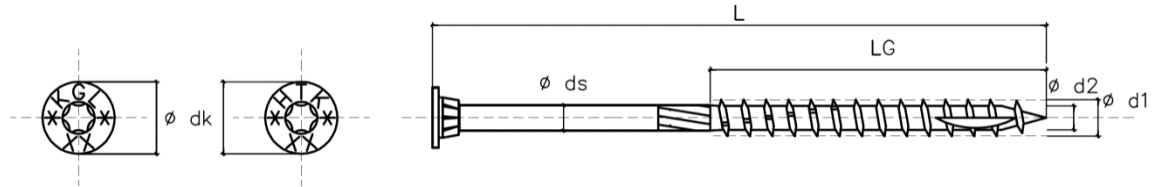

d₁ 4.00 mm		d₁ 4.50 mm		d₁ 5.00 mm		d₁ 6.00 mm		d₁ 8.00 mm		d₁ 10.00 mm		d₁ 12.00 mm	
L	L_G	L	L_G	L	L_G	L	L_G	L	L_G	L	L_G	L	L_G
[mm]	[mm]	[mm]	[mm]	[mm]	[mm]	[mm]	[mm]	[mm]	[mm]	[mm]	[mm]	[mm]	[mm]
25	20	25	20	40	20	40	35	40	32	60	52	160	80
30	16	30	25	45	24	50	35	60	52	80	52	200	80
30	18	35	18	50	24	50	45	80	52	90	52	200	100
30	25	35	24	50	30	60	30	90	52	100	52	220	80
35	16	40	24	60	30	60	35	100	52	120	52	220	100
35	18	45	24	60	35	70	30	100	60	120	60	240	80
40	24	45	30	70	35	70	40	100	80	120	80	240	100
45	24	50	24	70	40	80	40	120	52	140	52	260	80
45	30	50	30	80	40	80	50	120	60	140	60	260	100
50	24	60	30	80	50	90	40	120	80	140	80	280	80
50	30	60	35	90	45	90	50	140	52	160	80	280	100
60	30	70	35	90	55	90	55	140	60	180	80	300	80
60	35	70	40	100	50	100	50	140	80	180	90	300	100
70	35	80	40	100	60	100	60	160	80	200	80	300	120
70	40			110	50	110	50	160	90	200	100	320	80
80	40			110	55	110	60	160	100	220	80	320	100
				110	60	120	50	180	80	220	100	320	120
				120	50	120	60	180	90	240	80	340	80
				120	60	120	75	180	100	240	100	340	100
						130	50	200	80	260	80	340	120
						130	60	200	100	260	100	360	80
						130	75	220	80	280	80	360	100
						140	75	220	100	280	100	360	120
						140	80	240	80	300	80	380	80
						150	75	240	100	300	100	380	100
						150	80	260	80	300	120	380	120
						160	75	260	100	320	80	400	80
						160	90	280	80	320	100	400	100
						180	75	280	100	320	120	400	120
						180	100	300	80	340	80	440	100
						200	75	300	100	340	100	440	120
						200	100	300	120	340	120	480	100
						220	75	320	80	360	80	480	120
						220	100	320	100	360	100	500	100
						240	75	320	120	360	120	500	120
						240	100	340	80	380	80	520	100
						260	75	340	100	380	100	520	120
						260	100	340	120	380	120	540	100
						280	75	360	80	400	80	540	120
						280	100	360	100	400	100	550	100
						300	75	360	120	400	120	550	120
						300	100	380	80	420	80	560	100
								380	100	420	100	560	120
								380	120	420	120	600	100
								400	80	440	100	600	120
								400	100	440	120		
								400	120	450	100		
								420	80	450	120		
								420	100	460	100		
								420	120	460	120		
								440	100	480	100		
								440	120	480	120		
								450	100	500	100		
								450	120	500	120		
								460	100				
								460	120				
								480	100				
								480	120				
								500	100				
								500	120				

Tolerance (L and L_G): + 2.00 mm - 1.00 mm / All specification in [mm] / Intermediate length (L) and thread length (L_G) are possible.

Rotho Blaas Screws “TBS”

d₁ [mm]	6.00 ± 0.15	8.00 ± 0.20	8.00 ± 0.20	10.00 ± 0.25
d₂ [mm]	3.95 ± 0.10	5.40 ± 0.13	5.40 ± 0.13	6.40 ± 0.16
d_s [mm]	4.30 ± 0.11	5.80 ± 0.14	5.80 ± 0.14	7.00 ± 0.18
d_k [mm]	15.50 ± 0.38	19.00 ± 0.47	22.00 ± 0.55	25.00 ± 0.62

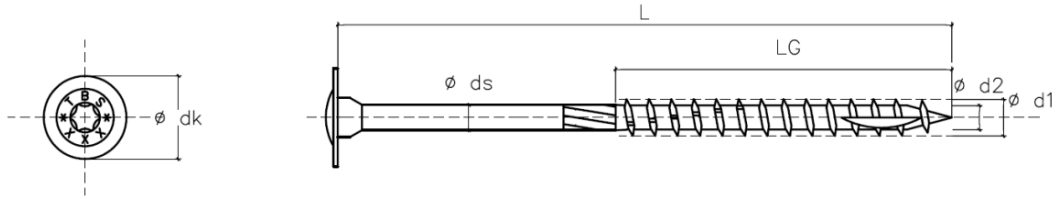

d₁ 6.00 mm		d₁ 8.00 mm		d₁ 10.00 mm	
L	L_G	L	L_G	L	L_G
[mm]	[mm]	[mm]	[mm]	[mm]	[mm]
40	35	40	32	60	52
50	35	60	52	80	52
50	45	80	52	90	52
60	30	90	52	100	52
60	35	100	52	120	52
70	30	100	60	120	60
70	40	100	80	120	80
80	40	120	52	140	52
80	50	120	60	140	60
90	40	120	80	140	80
90	50	140	52	160	80
90	55	140	60	180	80
100	50	140	80	180	90
100	60	160	80	200	80
110	50	160	90	200	100
110	60	160	100	220	80
120	50	180	80	220	100
120	60	180	90	240	80
120	75	180	100	240	100
130	50	200	80	260	80
130	60	200	100	260	100
130	75	220	80	280	80
140	75	220	100	280	100
140	80	240	80	300	80
150	75	240	100	300	100
150	80	260	80	300	120
160	75	260	100	320	80
160	90	280	80	320	100
180	75	280	100	320	120
180	100	300	80	340	80
200	75	300	100	340	100
200	100	300	120	340	120
220	75	320	80	360	80
220	100	320	100	360	100
240	75	320	120	360	120
240	100	340	80	380	80
260	75	340	100	380	100
260	100	340	120	380	120
280	75	360	80	400	80
280	100	360	100	400	100
300	75	360	120	400	120
300	100	380	80	420	80
		380	100	420	100
		380	120	420	120
		400	80	440	100
		400	100	440	120
		400	120	450	100
		420	80	450	120
		420	100	460	100
		420	120	460	120
		440	100	480	100
		440	120	480	120
		450	100	500	100
		450	120	500	120
		460	100		
		460	120		
		480	100		
		480	120		
		500	100		
		500	120		

Tolerance (L and L_G): + 2.00 mm - 1.00 mm / All specification in [mm] / Intermediate length (L) and thread length (L_G) are possible.

Rotho Blaas Screws “GHSK”

d₁ [mm]	6.00 ± 0.15	8.00 ± 0.20	8.00 ± 0.20	10.00 ± 0.25
d₂ [mm]	3.95 ± 0.10	5.40 ± 0.13	5.40 ± 0.13	6.40 ± 0.16
d_s [mm]	4.30 ± 0.11	5.80 ± 0.14	5.80 ± 0.14	7.00 ± 0.18
d_K [mm]	15.50 ± 0.38	19.00 ± 0.47	22.00 ± 0.55	25.00 ± 0.62

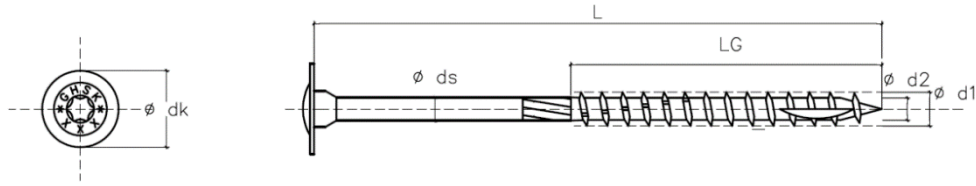

d₁ 6.00 mm		d₁ 8.00 mm		d₁ 10.00 mm	
L	L_G	L	L_G	L	L_G
[mm]	[mm]	[mm]	[mm]	[mm]	[mm]
40	35	40	32	60	52
50	35	60	52	80	52
50	45	80	52	90	52
60	30	90	52	100	52
60	35	100	52	120	52
70	30	100	60	120	60
70	40	100	80	120	80
80	40	120	52	140	52
80	50	120	60	140	60
90	40	120	80	140	80
90	50	140	52	160	80
90	55	140	60	180	80
100	50	140	80	180	90
100	60	160	80	200	80
110	50	160	90	200	100
110	60	160	100	220	80
120	50	180	80	220	100
120	60	180	90	240	80
120	75	180	100	240	100
130	50	200	80	260	80
130	60	200	100	260	100
130	75	220	80	280	80
140	75	220	100	280	100
140	80	240	80	300	80
150	75	240	100	300	100
150	80	260	80	300	120
160	75	260	100	320	80
160	90	280	80	320	100
180	75	280	100	320	120
180	100	300	80	340	80
200	75	300	100	340	100
200	100	300	120	340	120
220	75	320	80	360	80
220	100	320	100	360	100
240	75	320	120	360	120
240	100	340	80	380	80
260	75	340	100	380	100
260	100	340	120	380	120
280	75	360	80	400	80
280	100	360	100	400	100
300	75	360	120	400	120
300	100	380	80	420	80
		380	100	420	100
		380	120	420	120
		400	80	440	100
		400	100	440	120
		400	120	450	100
		420	80	450	120
		420	100	460	100
		420	120	460	120
		440	100	480	100
		440	120	480	120
		450	100	500	100
		450	120	500	120
		460	100		
		460	120		
		480	100		
		480	120		
		500	100		
		500	120		

Tolerance (L and L_G): + 2.00 mm - 1.00 mm / All specification in [mm] / Intermediate length (L) and thread length (L_G) are possible.

Rotho Blaas Screws “TELLER” or “TLL” or “HTT”

d₁ [mm]	6.00 ± 0.15	8.00 ± 0.20	8.00 ± 0.20	10.00 ± 0.25
d₂ [mm]	3.95 ± 0.10	5.40 ± 0.13	5.40 ± 0.13	6.40 ± 0.16
d_s [mm]	4.30 ± 0.11	5.80 ± 0.14	5.80 ± 0.14	7.00 ± 0.18
d_k [mm]	15.50 ± 0.38	19.00 ± 0.47	22.00 ± 0.55	25.00 ± 0.62

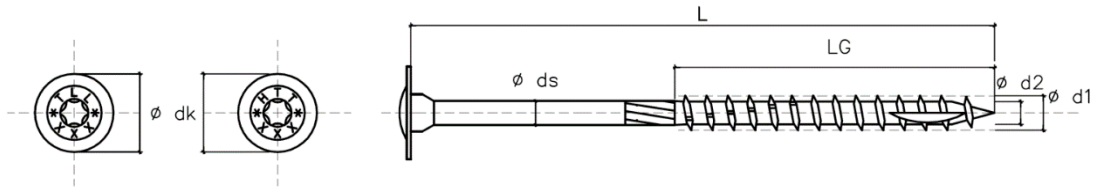

d₁ 6.00 mm		d₁ 8.00 mm		d₁ 10.00 mm	
L [mm]	L_G [mm]	L [mm]	L_G [mm]	L [mm]	L_G [mm]
40	35	40	32	60	52
50	35	60	52	80	52
50	45	80	52	90	52
60	30	90	52	100	52
60	35	100	52	120	52
70	30	100	60	120	60
70	40	100	80	120	80
80	40	120	52	140	52
80	50	120	60	140	60
90	40	120	80	140	80
90	50	140	52	160	80
90	55	140	60	180	80
100	50	140	80	180	90
100	60	160	80	200	80
110	50	160	90	200	100
110	60	160	100	220	80
120	50	180	80	220	100
120	60	180	90	240	80
120	75	180	100	240	100
130	50	200	80	260	80
130	60	200	100	260	100
130	75	220	80	280	80
140	75	220	100	280	100
140	80	240	80	300	80
150	75	240	100	300	100
150	80	260	80	300	120
160	75	260	100	320	80
160	90	280	80	320	100
180	75	280	100	320	120
180	100	300	80	340	80
200	75	300	100	340	100
200	100	300	120	340	120
220	75	320	80	360	80
220	100	320	100	360	100
240	75	320	120	360	120
240	100	340	80	380	80
260	75	340	100	380	100
260	100	340	120	380	120
280	75	360	80	400	80
280	100	360	100	400	100
300	75	360	120	400	120
300	100	380	80	420	80
		380	100	420	100
		380	120	420	120
		400	80	440	100
		400	100	440	120
		400	120	450	100
		420	80	450	120
		420	100	460	100
		420	120	460	120
		440	100	480	100
		440	120	480	120
		450	100	500	100
		450	120	500	120
		460	100		
		460	120		
		480	100		
		480	120		
		500	100		
		500	120		

Tolerance (L and L_G): + 2.00 mm - 1.00 mm / All specification in [mm] / Intermediate length (L) and thread length (L_G) are possible.

Rotho Blaas Screws “GWZ” and “GWS”

d₁ [mm]	7.00 ± 0.17	9.00 ± 0.22	11.00 ± 0.27
d₂ [mm]	4.60 ± 0.11	5.90 ± 0.15	6.60 ± 0.17
d_s [mm]	5.00 ± 0.12	6.50 ± 0.16	7.70 ± 0.19
d_k [mm] Type Z	9.50 ± 0.24	11.50 ± 0.29	13.50 ± 0.34
d_k [mm] Type S	13.00 ± 0.32	16.00 ± 0.40	19.30 ± 0.48

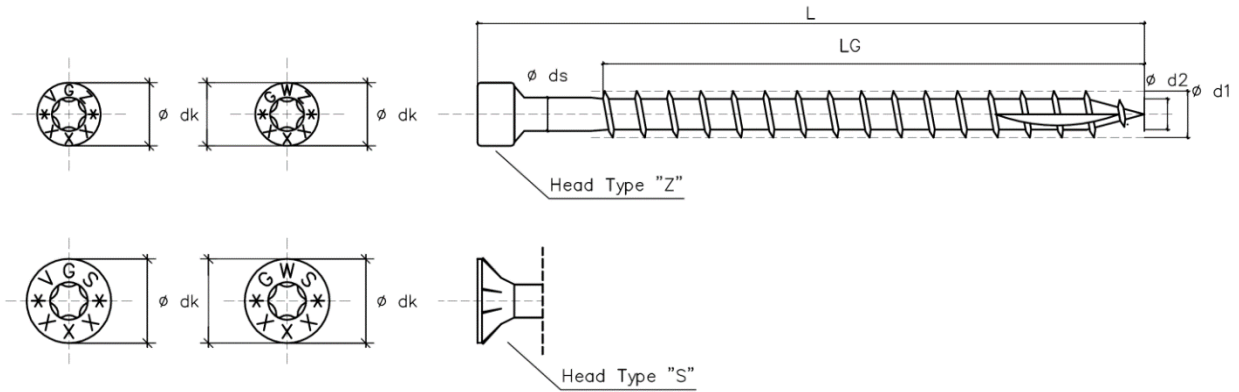

d₁ 7.00 mm		d₁ 9.00 mm		d₁ 11.00 mm	
L [mm]	L_G [mm]	L [mm]	L_G [mm]	L [mm]	L_G [mm]
100	80	140	120	100	80
100	90	140	130	100	90
120	100	160	140	125	105
120	110	160	150	125	115
140	120	180	160	150	130
140	130	180	170	150	140
160	140	200	180	175	155
160	150	200	190	175	165
180	160	220	200	200	180
180	170	220	210	200	190
200	180	240	220	220	200
200	190	240	230	220	210
220	200	260	240	240	220
220	210	260	250	240	230
240	220	280	260	250	230
240	230	280	270	250	240
260	240	300	280	260	240
260	250	300	290	260	250
280	260	320	300	280	260
280	270	320	310	280	270
300	280	340	300	300	280
300	290	340	320	300	290
320	300	360	320	325	305
320	310	360	340	325	315
340	300	380	340	350	330
340	320	380	360	375	355
360	320	400	360	400	380
360	340	400	380	425	405
380	340	425	385	450	430
380	360	425	405	475	455
400	360	450	410	500	480
400	380	450	430	525	505
		475	435	550	530
		475	455	575	555
		500	460	600	580
		500	480		

Tolerance (L and L_G): + 2.00 mm - 1.00 mm / All specification in [mm] / Intermediate length (L) and thread length (L_G) are possible.

Rotho Blaas Screws “HUS”, “SCB”, “SHT”, “SUS”

d₁ SCREW	6.00	8.00	10.00	12.00
D₁ [mm]	7.50 ± 0.19	8.50 ± 0.21	11.00 ± 0.28	14.00 ± 0.35
D₂ [mm]	20.00 ± 0.50	25.00 ± 0.63	32.00 ± 0.80	37.00 ± 0.93
S [mm]	4.00 ± 0.10	5.00 ± 0.13	6.00 ± 0.15	7.50 ± 0.19

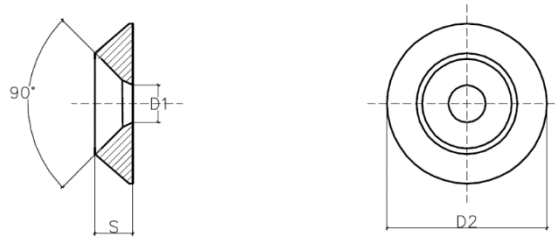

All specification in [mm] / Intermediate size are possible. / Material: carbon steel or stainless steel

Annex B Minimum distances and spacing

Axially loaded screws Single configuration

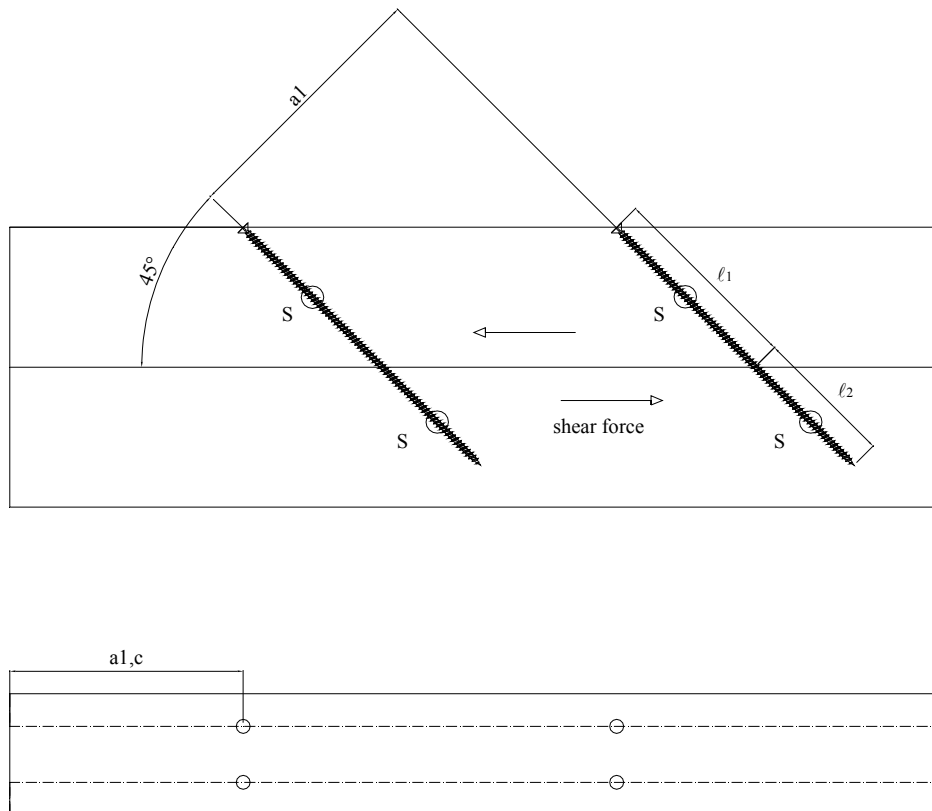

$$\begin{aligned}
 a_1 &\geq 5 \cdot d \\
 a_2 &\geq 2,5 \cdot d \quad \text{if } a_1 \cdot a_2 \geq 25 \cdot d^2 \\
 a_{3,c} &\geq 10 \cdot d \\
 a_{4,c} &\geq 4 \cdot d
 \end{aligned}$$

Minimum distances and spacing see also 4.2

Minimum timber thickness $t = 12 \cdot d$, see also 4.2

S = centroid of the part of the screw in the timber

Axially loaded screws
Crosswise configuration

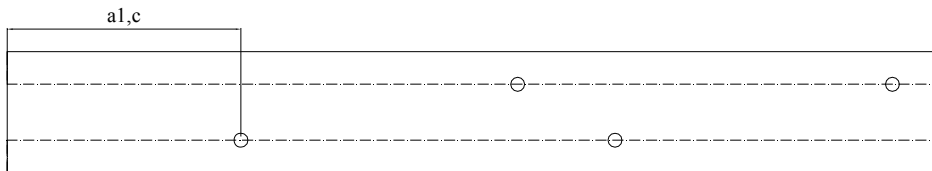
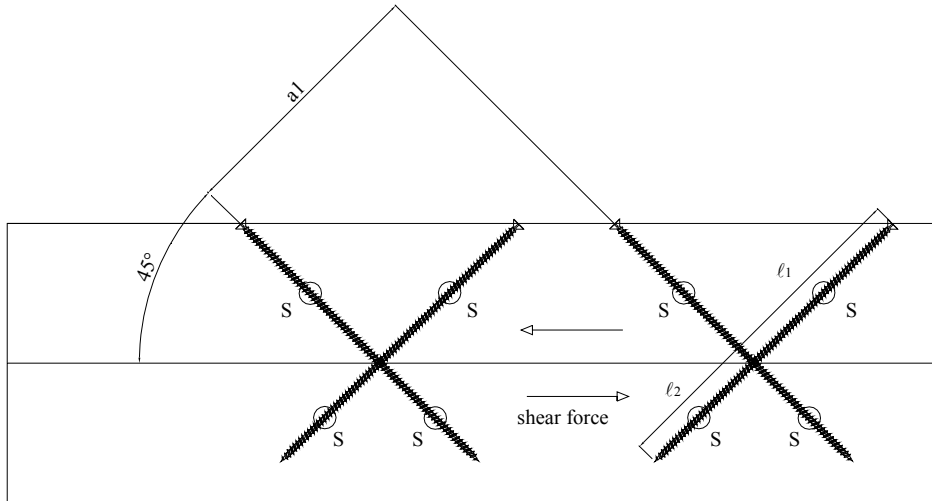

$$\begin{aligned}
 a_1 &\geq 5 \cdot d \\
 a_2 &\geq 1,5 \cdot d \quad \text{if } a_1 \cdot a_2 \geq 25 \cdot d^2 \\
 a_{3,c} &\geq 10 \cdot d \\
 a_{4,c} &\geq 4 \cdot d
 \end{aligned}$$

Minimum distances and spacing see also 4.2
 Minimum timber thickness $t = 12 \cdot d$, see also 4.2

S = centroid of the part of the screw in the timber

Axially or laterally loaded screws in the plane or edge surface of cross laminated timber

Definition of spacing, end and edge distances in the plane surface unless otherwise specified in the technical specification (ETA or hEN) for the cross laminated timber:

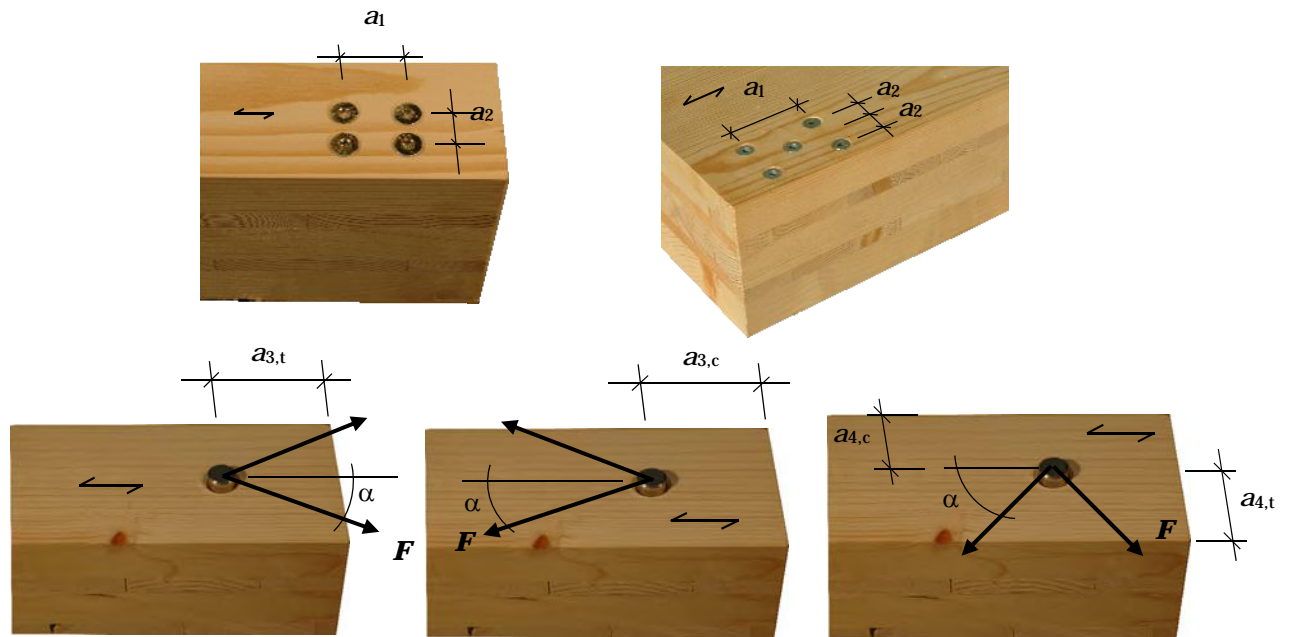

Definition of spacing, end and edge distances in the edge surface unless otherwise specified in the technical specification (ETA or hEN) for the cross laminated timber:

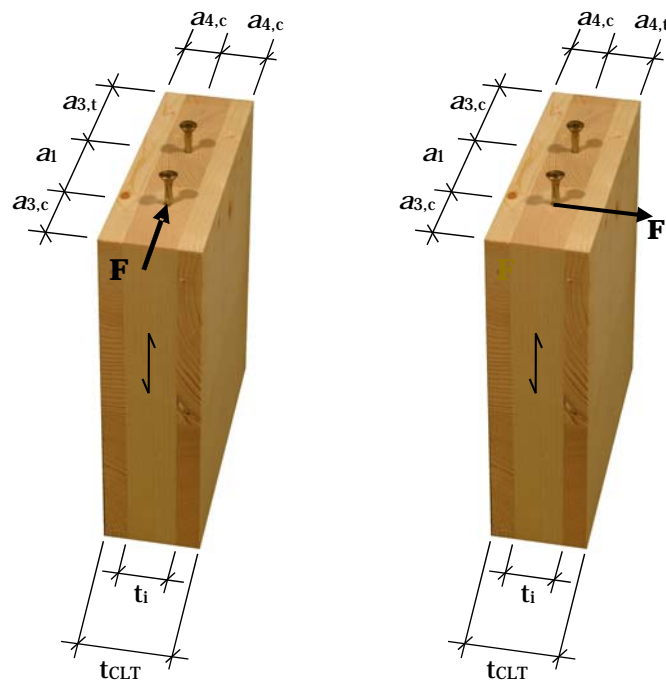
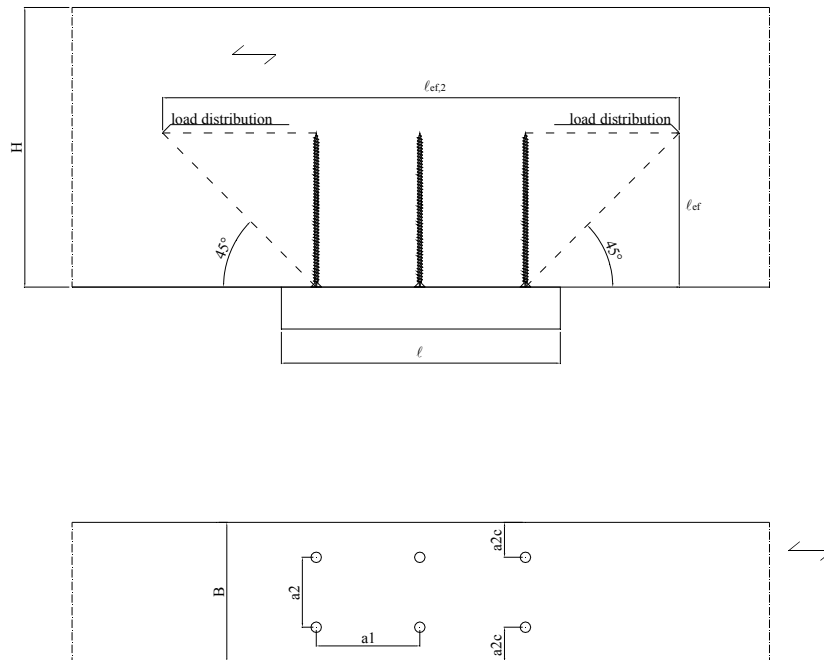

Table B1: Minimum spacing, end and edge distances of screws in the plane or edge surfaces of cross laminated timber

	a_1	$a_{3,t}$	$a_{3,c}$	a_2	$a_{4,t}$	$a_{4,c}$
Plane surface (see Figure 1)	$4 \cdot d$	$6 \cdot d$	$6 \cdot d$	$2,5 \cdot d$	$6 \cdot d$	$2,5 \cdot d$
Edge surface (see Figure 2)	$10 \cdot d$	$12 \cdot d$	$7 \cdot d$	$4 \cdot d$	$6 \cdot d$	$3 \cdot d$

Annex C Compression reinforcement

Reinforced centre-bearing



- H component height [mm]
- B bearing width [mm]
- l_{ef} point side penetration length [mm]
- $l_{ef,2}$ effective distribution length in the plane of the screw tips [mm]
 $= 2 \cdot l_{ef} + (n_0 - 1) \cdot a_1$ for centre-bearings

Reinforced end-bearing

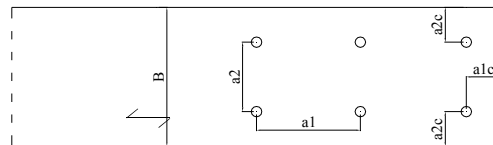
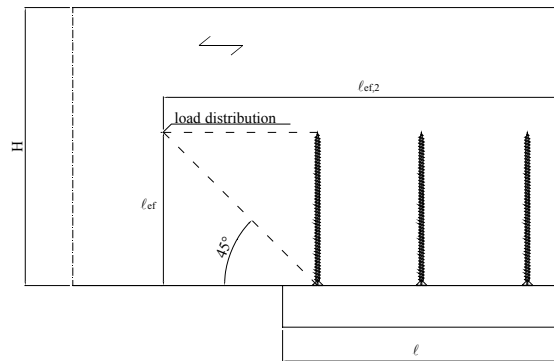

- H component height [mm]
- B bearing width [mm]
- ℓ_{ef} point side penetration length [mm]
- $\ell_{ef,2}$ effective distribution length in the plane of the screw tips [mm]
 $= \ell_{ef} + (n_0 - 1) \cdot a_1 + \min(\ell_{ef}, a_{1,c})$ for end-bearings

Annex D

Thermal insulation material on top of rafters or facades

Rotho Blaas screws with an outer thread diameter of at least 6 mm may also be used for the fixing of thermal insulation on top of rafters.

The thickness of the insulation shall not exceed 300 mm. The rafter insulation must be placed on top of solid timber or glued laminated timber rafters and be fixed by battens arranged parallel to the rafters or by wood-based panels on top of the insulation layer. The insulation of vertical facades is also covered by the rules given here.

Screws must be screwed in the rafter through the battens or panels and the insulation without pre-drilling in one sequence.

The angle α between the screw axis and the grain direction of the rafter should be between 30° and 90°.

The rafter consists of solid timber (softwood) according to EN 338, glued laminated timber according to EN 14081, cross-laminated timber, or laminated veneer lumber according to EN 14374 or to ETA or similar glued members according to ETA.

The battens must be from solid timber (softwood) according to EN 338:2003-04. The minimum thickness t and the minimum width b of the battens is given as follows:

Screws $d \leq 8$ mm:	$b_{\min} = 50$ mm	$t_{\min} = 30$ mm
Screws $9 \leq d \leq 10$ mm:	$b_{\min} = 60$ mm	$t_{\min} = 40$ mm
Screws $d = 11$ mm:	$b_{\min} = 80$ mm	$t_{\min} = 60$ mm
Screws $d = 12$ mm:	$b_{\min} = 100$ mm	$t_{\min} = 80$ mm

The insulation must comply with a ETA.

Friction forces shall not be considered for the design of the characteristic axial capacity of the screws.

The anchorage of wind suction forces as well as the bending stresses of the battens or the boards, respectively, shall be considered in design. Additional screws perpendicular to the grain of the rafter (angle $\alpha = 90^\circ$) may be arranged if necessary.

The maximum screw spacing is $e_s = 1,75$ m.

Thermal insulation on rafters with parallel inclined screws

Mechanical model

The system of rafter, thermal insulation material on top of rafter and battens parallel to the rafter may be considered as a beam on elastic foundation. The batten represents the beam, and the thermal insulation material on top of the rafter the elastic foundation. The minimum compression stress of the thermal insulation material at 10 % deformation, measured according to EN 826 (1), shall be $\sigma_{(10\%)} = 0,05 \text{ N/mm}^2$. The batten is loaded perpendicular to the axis by point loads F_b . Further point loads F_s are from the shear load of the roof due to dead and snow load, which are transferred from the screw heads into the battens.

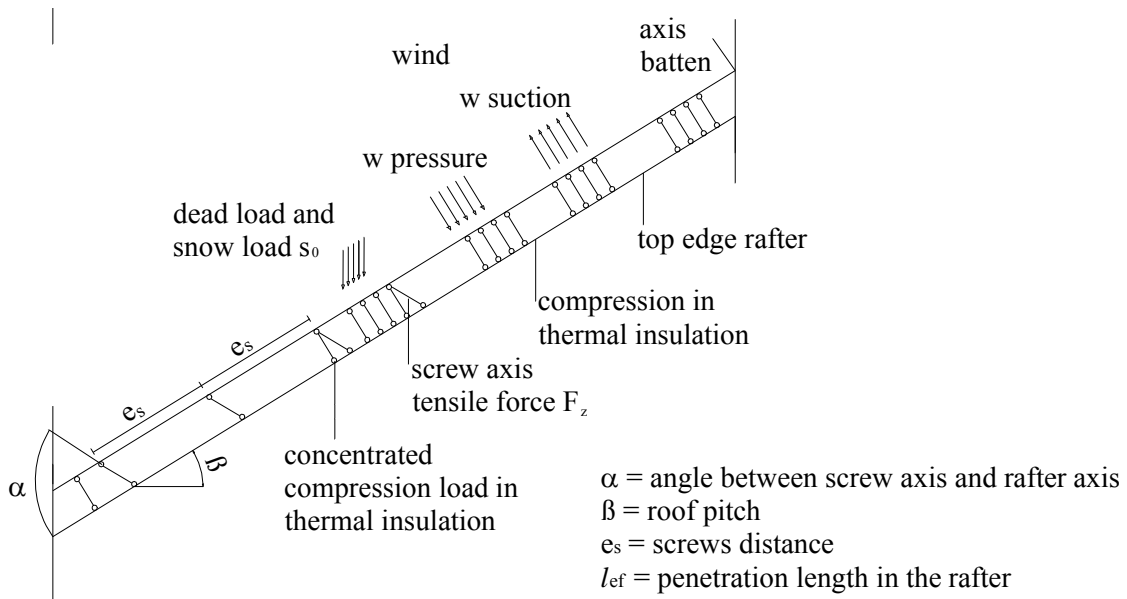
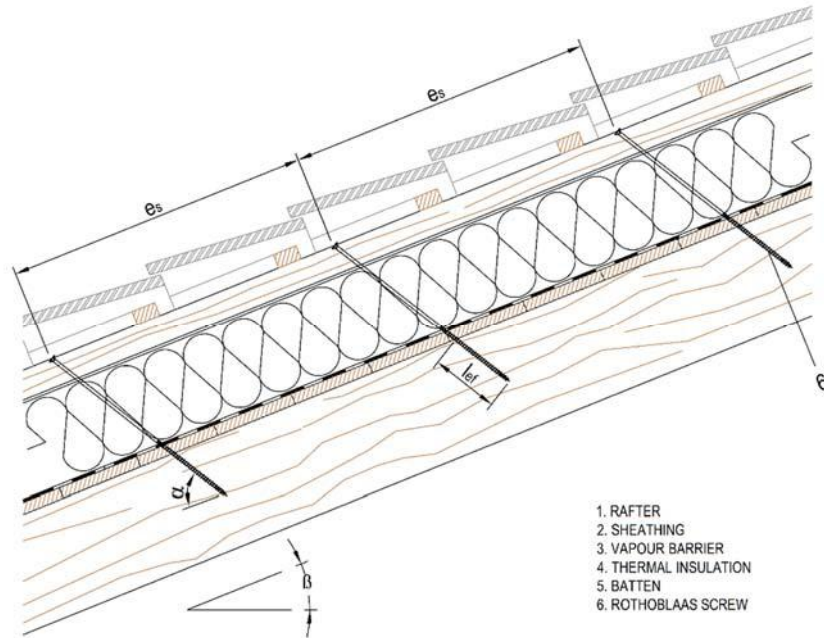

(1) EN 826:1996 Thermal insulating products for building applications - Determination of compression behaviour

Design of the battens

The bending stresses are calculated as:

$$M = \frac{(F_b + F_s) \cdot \ell_{\text{char}}}{4}$$

where

$$\ell_{\text{char}} = \text{characteristic length } \ell_{\text{char}} = \sqrt[4]{\frac{4 \cdot EI}{w_{\text{ef}} \cdot K}}$$

EI = bending stiffness of the batten

K = coefficient of subgrade

w_{ef} = effective width of the thermal insulation material

F_b = point loads perpendicular to the battens

F_s = point loads perpendicular to the battens, load application in the area of the screw heads

The coefficient of subgrade K may be calculated from the modulus of elasticity E_{HI} and the thickness t_{HI} of the thermal insulation material if the effective width w_{ef} of the thermal insulation material under compression is known. Due to the load extension in the thermal insulation material the effective width w_{ef} is greater than the width of the batten or rafter, respectively. For further calculations, the effective width w_{ef} of the thermal insulation material may be determined according to:

$$w_{\text{ef}} = w + t_{\text{HI}} / 2$$

where

w = minimum width of the batten or rafter, respectively

t_{HI} = thickness of the thermal insulation material

$$K = \frac{E_{\text{HI}}}{t_{\text{HI}}}$$

The following condition shall be satisfied:

$$\frac{\sigma_{\text{m,d}}}{f_{\text{m,d}}} = \frac{M_{\text{d}}}{W \cdot f_{\text{m,d}}} \leq 1$$

For the calculation of the section modulus W the net cross section has to be considered.

The shear stresses shall be calculated according to:

$$V = \frac{(F_b + F_s)}{2}$$

The following condition shall be satisfied:

$$\frac{\tau_{\text{d}}}{f_{\text{v,d}}} = \frac{1,5 \cdot V_{\text{d}}}{A \cdot f_{\text{v,d}}} \leq 1$$

For the calculation of the cross section area the net cross section has to be considered.

Design of the thermal insulation material

The compressive stresses in the thermal insulation material shall be calculated according to:

$$\sigma = \frac{1,5 \cdot F_b + F_s}{2 \cdot \ell_{\text{char}} \cdot w}$$

The design value of the compressive stress shall not be greater than 110 % of the compressive stress at 10 % deformation calculated according to EN 826.

Design of the screws

The screws are loaded predominantly axially. The axial tension force in the screw may be calculated from the shear loads of the roof R_s :

$$T_s = \frac{R_s}{\cos \alpha}$$

The load-carrying capacity of axially loaded screws is the minimum design value of the axial withdrawal capacity of the threaded part of the screw, the head pull-through capacity of the screw and the tensile capacity of the screw.

In order to limit the deformation of the screw head for thermal insulation material thicknesses over 200 mm or with compressive strength below 0,12 N/mm², respectively, the axial withdrawal capacity of the screws shall be reduced by the factors k_1 and k_2 :

- for "HBS", "HBS+", "TBS", "KKF", "SCI" screws with partial thread:

$$F_{ax,\alpha,Rd} = \min \left\{ \frac{f_{ax,d} \cdot d \cdot \ell_{ef} \cdot k_1 \cdot k_2}{1,2 \cdot \cos^2 \alpha + \sin^2 \alpha} \cdot \left(\frac{\rho_k}{350} \right)^{0,8}; f_{head,d} \cdot d_h^2 \cdot \left(\frac{\rho_k}{350} \right)^{0,8}; \frac{f_{tens,k}}{\gamma_{M2}} \right\}$$

- for "DGZ", "VGS", "GWZ", "GWS", "VGZ" screws with full thread or double thread:

$$F_{ax,\alpha,Rd} = \min \left\{ \begin{array}{l} \frac{f_{ax,d} \cdot d \cdot \ell_{ef} \cdot k_1 \cdot k_2}{1,2 \cdot \cos^2 \alpha + \sin^2 \alpha} \cdot \left(\frac{\rho_k}{350} \right)^{0,8} \\ \max \left\{ f_{head,d} \cdot d_h^2; \frac{f_{ax,d} \cdot d \cdot \ell_{ef,b}}{1,2 \cdot \cos^2 \alpha + \sin^2 \alpha} \right\} \cdot \left(\frac{\rho_k}{350} \right)^{0,8} \\ \frac{f_{tens,k}}{\gamma_{M2}} \end{array} \right\}$$

where:

$F_{ax,\alpha,d}$	design value of the load-carrying capacity of axially loaded screws [N]
$f_{ax,d}$	design value of the axial withdrawal parameter of the threaded part of the screw in the rafter or batten, $f_{ax,d}$ does not apply for wood-based panels except plywood, LVL or solid wood panels [N/mm ²] ($f_{ax,k} = 11,7$ N/mm ²)
d	outer thread diameter of the screw [mm]
ℓ_{ef}	point side penetration length of the threaded part of the screw in the batten, $\ell_{ef} \geq 40$ mm [mm]
$\ell_{ef,b}$	length of the threaded part in the batten including the head for tensile and excluding the head for compressive force [mm]
α	angle between grain and screw axis ($30^\circ \leq \alpha \leq 90^\circ$)
ρ_k	characteristic density of the wood-based member [kg/m ³]
$f_{head,d}$	design value of the head pull-through capacity of the screw [N/mm ²]
d_h	head diameter [mm]
$f_{tens,k}$	characteristic tensile capacity of the screw [N]
γ_{M2}	partial factor according to EN 1993-1-1 or to the particular national annex
k_1	$\min \{1; 200/t_{HI}\}$
k_2	$\min \{1; \sigma_{10\%}/0,12\}$
t_{HI}	thickness of the thermal insulation material [mm]
$\sigma_{10\%}$	compressive stress of the thermal insulation material under 10 % deformation [N/mm ²]

If k_1 and k_2 are considered, the deflection of the battens does not need to be considered. Alternatively to the battens, panels with a minimum thickness of 20 mm from plywood according to EN 636 or an ETA or national provisions that apply at the installation site, particle board according to EN 312 or an ETA or national provisions that apply at the installation site, oriented strand board according to EN 300 or an ETA or national provisions that apply at the installation site and solid wood panels according to EN 13353 or an ETA or national provisions that apply at the installation site or cross laminated timber according to an ETA may be used.

Thermal insulation on rafters with alternatively inclined “DGZ”, “GWZ”, “GWS”, “VGZ” or “VGS” screws

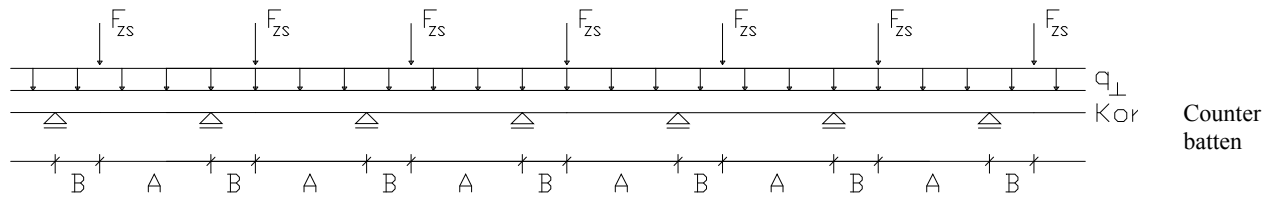
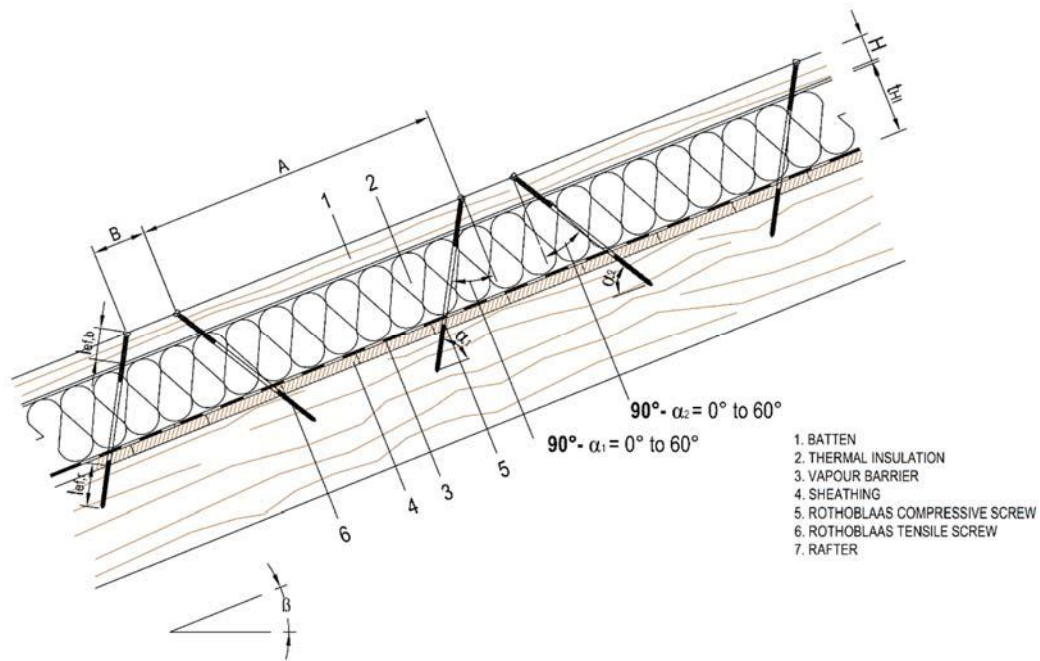

Mechanical model

Depending on the screw spacing and the arrangement of tensile and compressive screws with different inclinations the battens are loaded by significant bending moments. The bending moments are derived based on the following assumptions:

- The tensile and compressive loads in the screws are determined based on equilibrium conditions from the actions parallel and perpendicular to the roof plane. These actions are constant line loads q_{\perp} and q_{\parallel} .
- The screws act as hinged columns supported 10 mm within the batten or rafter, respectively. The effective column length consequently equals the length of the screw between batten and rafter plus 20 mm.
- The batten is considered as a continuous beam with a constant span $\ell = A + B$. The compressive screws constitute the supports of the continuous beam while the tensile screws transfer concentrated loads perpendicular to the batten axis.

The screws are predominantly loaded in withdrawal or compression, respectively. The screw’s normal forces are determined based on the loads parallel and perpendicular to the roof plane:

Compressive screw:
$$F_{c,Ed} = (A + B) \cdot \left(-\frac{q_{\parallel} \cdot \sin \alpha_2 + q_{\perp} \cdot \cos \alpha_2}{\sin(\alpha_1 + \alpha_2)} \right)$$

Tensile screw:
$$F_{t,Ed} = (A + B) \cdot \left(\frac{q_{II} \cdot \sin \alpha_1 - q_{\perp} \cdot \cos \alpha_1}{\sin(\alpha_1 + \alpha_2)} \right)$$

The bending moments in the batten follow from the constant line load q_{\perp} and the load components perpendicular to the batten from the tensile screws. The span of the continuous beam is $(A + B)$. The load component perpendicular to the batten from the tensile screw is:

$$F_{ZS,Ed} = (A + B) \cdot \left(\frac{q_{II} \cdot \sin \alpha_1 \cdot \sin \alpha_2 - q_{\perp} \cdot \cos \alpha_1 \cdot \sin \alpha_2}{\sin(\alpha_1 + \alpha_2)} \right)$$

where:

- q_{II} constant line load parallel to batten
- q_{\perp} constant line load perpendicular to batten
- α_1 angle between compressive screw axis and grain direction
- α_2 angle between tensile screw axis and grain direction

A positive value for F_{ZS} means a load towards the rafter, a negative value a load away from the rafter.

Design of the screws

The load-carrying capacity of the screws shall be calculated as follows:

Screws loaded in tension:

$$F_{ax,\alpha,Rd} = \min \left\{ \frac{f_{ax,d} \cdot d \cdot \ell_{ef,b}}{1,2 \cdot \cos^2 \alpha + \sin^2 \alpha} \cdot \left(\frac{\rho_{b,k}}{350} \right)^{0,8}; \frac{f_{ax,d} \cdot d \cdot \ell_{ef,r}}{1,2 \cdot \cos^2 \alpha + \sin^2 \alpha} \cdot \left(\frac{\rho_{r,k}}{350} \right)^{0,8}; \frac{f_{tens,k}}{\gamma_{M2}} \right\}$$

Screws loaded in compression:

$$F_{ax,\alpha,Rd} = \min \left\{ \frac{f_{ax,d} \cdot d \cdot \ell_{ef,b}}{1,2 \cdot \cos^2 \alpha + \sin^2 \alpha} \cdot \left(\frac{\rho_{b,k}}{350} \right)^{0,8}; \frac{f_{ax,d} \cdot d \cdot \ell_{ef,r}}{1,2 \cdot \cos^2 \alpha + \sin^2 \alpha} \cdot \left(\frac{\rho_{r,k}}{350} \right)^{0,8}; \frac{\kappa_c \cdot N_{pl,k}}{\gamma_{M1}} \right\}$$

where:

- $F_{ax,\alpha,Rd}$ design value of the load-carrying capacity of the screw [N]
- $f_{ax,d}$ design value of the axial withdrawal parameter of the threaded part of the screw in the rafter or batten, $f_{ax,d}$ does not apply for wood-based panels except plywood, LVL or solid wood panels [N/mm²] ($f_{ax,k} = 11,7$ N/mm²)
- d outer thread diameter of the screw [mm]
- $\ell_{ef,b}$ penetration length of the threaded part of the screw in the batten [mm]
- $\ell_{ef,r}$ penetration length of the threaded part of the screw in the rafter, $\ell_{ef} \geq 40$ mm [mm]
- $\rho_{b,k}$ characteristic density of the batten [kg/m³]
- $\rho_{r,k}$ characteristic density of the rafter [kg/m³]
- α angle α_1 or α_2 between screw axis and grain direction, $30^\circ \leq \alpha_{\square} \leq 90^\circ$, $30^\circ \leq \alpha_2 \leq 90^\circ$
- $f_{tens,k}$ characteristic tensile capacity of the screw [N]
- γ_{M1}, γ_{M2} partial factor according to EN 1993-1-1 or to the particular national annex
- $\kappa_c \cdot N_{pl,k}$ buckling capacity of the screw [N]

Buckling capacity of the screw

Free screw length [mm]	“DGZ“		“GWZ”, “GWS”, “VGZ” or “VGS”		
	7 mm	9 mm	7 mm	9 mm	11 mm
	$\kappa_c \cdot N_{pl,k}$ [kN]	$\kappa_c \cdot N_{pl,k}$ [kN]	$\kappa_c \cdot N_{pl,k}$ [kN]	$\kappa_c \cdot N_{pl,k}$ [kN]	$\kappa_c \cdot N_{pl,k}$ [kN]
≤ 100	3,52	9,23	2,57	6,49	9,75
120	2,68	7,15	1,95	4,99	7,57
140	2,10	5,68	1,53	3,95	6,02
160	1,70	4,61	1,23	3,19	4,89
180	1,40	3,82	1,01	2,63	4,05
200	1,17	3,21	0,84	2,22	3,40
220	0,99	2,74	0,71	1,88	2,91
240	0,85	2,36	0,61	1,62	2,50
260	0,74	2,05	0,53	1,41	2,18
280	0,65	1,80	0,47	1,23	1,91
300	0,57	1,59	0,41	1,09	1,69
320		1,42			
340		1,27			
360		1,15			
380		1,04			
400		0,95			

where

free screw length = $t_{HI} / \sin \alpha$ [mm] ($\alpha = \alpha_1$ or α_2)