



ETA-Danmark A/S
Göteborg Plads 1
DK-2150 Nordhavn
Tel. +45 72 24 59 00
Fax +45 72 24 59 04
Internet www.etadanmark.dk

Authorised and notified according
to Article 29 of the Regulation (EU)
No 305/2011 of the European
Parliament and of the Council of 9
March 2011

MEMBER OF EOTA



European Technical Assessment ETA-11/0086 of 2015-01-26

I General Part

Technical Assessment Body issuing the ETA and designated according to Article 29 of the Regulation (EU) No 305/2011: ETA-Danmark A/S

Trade name of the construction product:

Rotho Blaas WHT hold downs and angle brackets

Product family to which the above construction product belongs:

Three-dimensional nailing plate (Angle brackets and hold-downs for timber-to-timber or timber-to-concrete or steel connections)

Manufacturer:

Rotho Blaas s.r.l
Via dell'Adige 2/1
IT-38040 Cortaccia (BZ)
Tel. + 39 0471 81 84 00
Fax + 39 0471 81 84 84
Internet www.rothoblaas.com

Manufacturing plant:

Rotho Blaas s.r.l
Manufacturing plant II

This European Technical Assessment contains:

26 pages including 2 annexes which form an integral part of the document

This European Technical Assessment is issued in accordance with Regulation (EU) No 305/2011, on the basis of:

Guideline for European Technical Approval (ETAG) No. 015 Three Dimensional Nailing Plates, April 2013, used as European Assessment Document (EAD).

This version replaces:

The previous ETA with the same number issued on 2011-02-01 and expiry on 2015-01-26

Translations of this European Technical Assessment in other languages shall fully correspond to the original issued document and should be identified as such.

Communication of this European Technical Assessment, including transmission by electronic means, shall be in full (excepted the confidential Annex(es) referred to above). However, partial reproduction may be made, with the written consent of the issuing Technical Assessment Body. Any partial reproduction has to be identified as such.

II SPECIFIC PART OF THE EUROPEAN TECHNICAL ASSESSMENT

1 Technical description of product and intended use

Technical description of the product

Rotho Blaas WHT angle brackets or hold-downs, respectively, are one-piece non-welded or welded, face-fixed angle brackets to be used in timber to timber or in timber to concrete or to steel connections. They are connected to construction members made of timber or wood-based products with profiled (ringed shank) nails or screws according to EN 14592 or screws and profiled nails according to ETA-13/0523 and to concrete or steel members with bolts or metal anchors.

The angle brackets or hold-downs with a steel plate thickness of 2 mm to 4 mm are made from pre-galvanized steel S250 GD / Z 275 or DX 51 D / Z 275 according to EN 10346 with $R_e \geq 250 \text{ N/mm}^2$, $R_m \geq 360 \text{ N/mm}^2$ and $A_{80} \geq 19\%$ or steel grade S355 according to EN 10025-2. The Washers are made from steel grade S235 according to EN 10025-2. Dimensions, hole positions and typical installations are shown in Annex A and B. Rotho Blaas angle brackets and hold-downs are made from steel with tolerances according to EN 10143.

2 Specification of the intended use in accordance with the applicable EAD

The angle brackets and hold-downs are intended for use in making connections in load bearing timber structures, as a connection between a column or a purlin and a concrete or steel member, where requirements for mechanical resistance and stability and safety in use in the sense of the Basic Works Requirements 1 and 4 of Regulation (EU) 305/2011 shall be fulfilled.

The static and kinematical behaviour of the timber members or the supports shall be as described in Annex B.

The wood members may be of solid timber, glued laminated timber and similar glued members, or wood-based structural members with a characteristic density from 290 kg/m^3 to 420 kg/m^3 . This requirement to the material of the wood members can be fulfilled by using the following materials:

- Structural solid timber classified to C14-C40 according to EN 14081,

- Glulam classified to GL24-GL36 according to EN 14080,
- LVL according to EN 14374,
- Parallam PSL,
- Intrallam LSL,
- Glued solid timber according to EN 14080,
- Cross laminated timber,
- Plywood according to EN 636

Annex B states the load-carrying capacities of the angle bracket connections for a characteristic density of 350 kg/m^3 . For timber or wood based material with a lower characteristic density than 350 kg/m^3 the load-carrying capacities shall be reduced by the k_{dens} factor:

$$k_{\text{dens}} = \left(\frac{\rho_k}{350} \right)^2$$

Where ρ_k is the characteristic density of the timber in kg/m^3 .

The design of the connections shall be in accordance with Eurocode 5 or a similar national Timber Code. The wood members shall have a thickness which is larger than the penetration depth of the fasteners into the members. If a wood-based panel interlayer is placed between the connector plate and the timber member, the lateral load-carrying capacity of the nail or screw, respectively, has to take into account the effect of the interlayer.

The angle brackets and hold-downs are primarily for use in timber structures subject to the dry, internal conditions defined by service classes 1 and 2 of Eurocode 5 and for connections subject to static or quasi-static loading.

The angle brackets may also be used in outdoor timber structures, service class 3, when a corrosion protection in accordance with Eurocode 5 is applied, or when stainless steel with similar or better characteristic yield and ultimate strength is employed. If a stainless steel with a lower characteristic yield or ultimate strength is employed, the load-carrying capacities $F_{m,Rk}$, $F_{v,Rk}$ or $F_{t,Rk}$ in Tables 1 and 2 (see annex B) are to be reduced proportionally.

The angle brackets and hold-downs may also be used for connections between two timber members.

The scope of the brackets regarding resistance to corrosion shall be defined according to national provisions that apply at the installation site considering environmental conditions.

The provisions made in this European Technical Assessment are based on an assumed intended working life of the connectors of 50 years.

The indications given on the working life cannot be interpreted as a guarantee given by the producer or Assessment Body, but are to be regarded only as a means for choosing the right products in relation to the expected economically reasonable working life of the works.

3 Performance of the product and references to the methods used for its assessment

Characteristic	Assessment of characteristic
3.1 Mechanical resistance and stability*) (BWR1)	
Characteristic load-carrying capacity	See Annex B
Stiffness	No performance determined
Ductility in cyclic testing	No performance determined
3.2 Safety in case of fire (BWR2)	
Reaction to fire	The angle brackets and hold-downs are made from steel classified as Euroclass A1 in accordance with EN 1350-1 and EC decision 96/603/EC, amended by EC Decision 2000/605/EC
3.3 Hygiene, health and the environment (BWR3)	
Influence on air quality	The product does not contain/release dangerous substances specified in TR 034, dated March 2012**)
3.7 Sustainable use of natural resources (BWR7)	
	No Performance Determined
3.8 General aspects related to the performance of the product	
	The angle brackets and hold-downs have been assessed as having satisfactory durability and serviceability when used in timber structures using the timber species described in Eurocode 5 and subject to the conditions defined by service class 1 and 2
Identification	See Annex A

*) See additional information in section 3.9 – 3.12.

**) In addition to the specific clauses relating to dangerous substances contained in this European technical Assessment, there may be other requirements applicable to the products falling within its scope (e.g. transposed European legislation and national laws, regulations and administrative provisions). In order to meet the provisions of the Construction Products Regulation, these requirements need also to be complied with, when and where they apply.

3.9 Methods of verification

The characteristic load-carrying capacities are based on the characteristic values of the nail or screw connections and the steel plates. To obtain design values the capacities have to be divided by different partial factors for the material properties, the nail connection in addition multiplied with the coefficient k_{mod} .

According to EN 1990 (Eurocode – Basis of design) paragraph 6.3.5 the design value of load-carrying capacity may be determined by reducing the characteristic values of the load-carrying capacity with different partial factors.

Thus, the characteristic values of the load-carrying capacity are determined also for timber failure $F_{Rk,H}$ (obtaining the embedment strength of nails or screws subjected to shear or the withdrawal capacity of the most loaded nail or screw, respectively) as well as for steel plate failure $F_{Rk,S}$. The design value of the load-carrying capacity is the smaller value of both load-carrying capacities.

$$F_{Rd} = \min \left\{ \frac{k_{mod} \cdot F_{Rk,H}}{\gamma_{M,H}}; \frac{F_{Rk,S}}{\gamma_{M,S}} \right\}$$

Therefore, for timber failure the load duration class and the service class are included. The different partial factors γ_M for steel or timber, respectively, are also correctly taken into account.

3.10 Mechanical resistance and stability

See annex B for the characteristic load-carrying capacity in the different directions F_1 to F_3 .

The characteristic capacities of the angle brackets and hold-downs are determined by calculation assisted by testing as described in the EOTA Guideline 015 clause 5.1.2. They should be used for designs in accordance with Eurocode 5 or a similar national Timber Code.

No performance has been determined in relation to ductility of a joint under cyclic testing. The contribution to the performance of structures in seismic zones, therefore, has not been assessed.

No performance has been determined in relation to the joint's stiffness properties to be used for the analysis of the serviceability limit state.

3.11 Aspects related to the performance of the product

3.11.1 Corrosion protection in service class 1 and 2.
In accordance with ETAG 015 the zinc-coated hold downs and angle brackets have a zinc coating weight of min Z275. The steel employed is S250 GD+Z275 to EN 10346:2009 or DX51D with min Z275 according to EN 10346:2009, and steel grade S355 according to EN 10025-2 with Fe Zn 12C.

3.12 General aspects related to the fitness for use of the product

The performance given in this ETA are based on the following:

- The structural members – the components 1 and 2 shown in the figure on page 12 – to which the brackets are fixed shall be:
 - Restrained against rotation.
 - Strength class C14 or better, see section 3 of this evaluation report
 - Free from wane under the bracket.
- The actual end bearing capacity of the timber member to be used in conjunction with the bracket is checked by the designer of the structure to ensure it is not less than the bracket capacity and, if necessary, the bracket capacity reduced accordingly.
- The gap between the timber members does not exceed 3 mm.

There are no specific requirements relating to preparation of the timber members.

4 Attestation and verification of constancy of performance (AVCP)

4.1 AVCP system

According to the decision 97/638/EC of the European Commission¹, as amended, the system(s) of assessment and verification of constancy of performance (see Annex V to Regulation (EU) No 305/2011) is 2+.

5 Technical details necessary for the implementation of the AVCP system, as foreseen in the applicable EAD

Technical details necessary for the implementation of the AVCP system are laid down in the control plan deposited at ETA-Danmark

Issued in Copenhagen on 2015-01-26 by

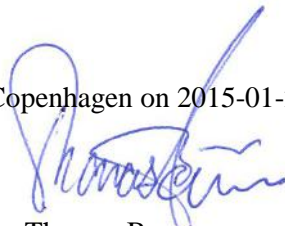

Thomas Bruun
Managing Director, ETA-Danmark

Annex A - Product details definitions

Table A.1 Materials specification

Bracket type	Thickness (mm)	Steel specification	Coating specification
WZU15550	3,0	S250 GD or DX51D	Z 275
WZU2002	2,0	S250 GD or DX51D	Z 275
WZU2004	4,0	S250 GD or DX51D	Z 275
WZU3002	2,0	S250 GD or DX51D	Z 275
WZU3004	4,0	S250 GD or DX51D	Z 275
WZU4002	2,0	S250 GD or DX51D	Z 275
WZU4004	4,0	S250 GD or DX51D	Z 275
WZU342 Strong	2,0	S250 GD or DX51D	Z 275
WZU422 Strong	2,0	S250 GD or DX51D	Z 275
WZU482 Strong	2,5	S250 GD or DX51D	Z 275
WHT340	3,0	S355	Fe Zn 12c
WHT440	3,0	S355	Fe Zn 12c
WHT540 Hole Ø1 7	3,0	S355	Fe Zn 12c
WHT620 Hole Ø 21	3,0	S355	Fe Zn 12c
WHT740	3,0	S355	Fe Zn 12c
WHT540 Hole Ø 22	3,0	S355	Fe Zn 12c
WHT620 Hole Ø 26	3,0	S355	Fe Zn 12c
WZUBS43 Washer	10,0	S 235	Fe Zn 12c
WZU STRONG Washer	15,0	S 235	Fe Zn 12c
WZU STRONG Washer	20,0	S 235	Fe Zn 12c
WZU STRONG Washer	20,0	S 235	Fe Zn 12c
WHTBS50 Washer WHTBS50L Washer	10,0	S 235	Fe Zn 12c
WHTBS70 Washer WHTBS70L Washer	20,0	S 235	Fe Zn 12c
WHTBS130 Washer	40,0	S 235	Fe Zn 12c

Table A.2 Range of sizes

Bracket type	Height (mm) vertical		Height (mm) horizontal		Width (mm)	
WZU15550	154	156	49	51	39	41
WZU2002	199	201	39	41	39	41
WZU2004	199	201	39	41	39	41
WZU3002	299	301	39	41	39	41
WZU3004	299	301	39	41	39	41
WZU4002	399	401	39	41	39	41
WZU4004	399	401	39	41	39	41
WZU342 Strong	339	341	179	181	39	41
WZU422 Strong	319	421	219	221	59	61
WZU482 Strong	479	481	99	101	59	61
WHT340	339	341	62	64	59	61
WHT440	439	441	62	64	64	61
WHT540 Hole Ø 17	539	541	62	64	59	61
WHT620 Hole Ø 21	619	621	62/82	64/84	79	81
WHT740	739	741	82	84	139	141
WHT540 Hole Ø 22	539	541	62	64	59	61
WHT620 Hole Ø 26	619	621	82	84	79	81
WZUBS43 Washer	-	-	39	41	42	44
WZU STRONG Washer	-	-	159	161	49	51
WZU STRONG Washer	-	-	199	201	59	61
WZU STRONG Washer	-	-	114	116	69	71
WHTBS50 Washer WHTBS50L Washer	-	-	55	57	49	51
WHTBS70 Washer WHTBS70L Washer	-	-	76	78	69	71
WHTBS130 Washer	-	-	79	81	129	131

Table A.3 Fastener specification

FASTENER	Length Min – max	Nail type
Profiled nail 4.0 mm	40 – 100 mm	Ringed shank nails according to EN 14592
GH-Nail 4.0 mm	40 – 100 mm	Ringed shank nails according to ETA-13/0523
GH-Screw 5.0 mm	35 – 70 mm	Self-tapping screws according to ETA-13/0523

In the load-carrying-capacities of the nailed or screwed connection in Annex B the capacities calculated from the formulas of Eurocode 5 are used assuming a thick steel plate when calculating the lateral fastener load-carrying-capacity. The load-carrying-capacities of the hold downs have been determined based on the use of connector nails \varnothing 4,0 mm or screws \varnothing 5,0 mm in accordance with the european technical approval for the nails or the screws. The characteristic withdrawal capacity of the nails according to EN 14592 has to be determined by calculation in accordance with EN 1995-1-1, paragraph 8.3.2 (head pull-through is not relevant):

$$F_{ax,Rk} = f_{1,k} \times d \times t_{pen}$$

Where:

$f_{1,k}$ Characteristic value of the withdrawal parameter in N/mm²

d Nail or screw diameter in mm

t_{pen} Penetration depth of the profiled shank in mm;

(4,0 x 40 mm $t_{pen} \geq 31$ mm; 4,0 x 50 mm $t_{pen} \geq 40$ mm; 4,0 x 60 mm $t_{pen} \geq 50$ mm)

Based on tests by Versuchsanstalt für Stahl, Holz und Steine, University of Karlsruhe, the characteristic value of the withdrawal resistance for the threaded nails according to EN 14592 can be calculated as:

$$f_{1,k} = 50 \times 10^{-6} \times \rho_k^2$$

Where:

ρ_k Characteristic density of the timber in kg/m³

The shape of the nail or screw directly under the head shall be in the form of a truncated cone with a diameter under the head which fits or exceeds the hole diameter.

BOLTS diameter	Correspondent Hole diameter	Bolt type
10.0 - 30.0 mm	Max. 2 mm. larger than the bolt diameter	Bolt according to EN 14592

METAL ANCHORS diameter	Correspondent Hole diameter	Anchor type
10.0 - 30.0 mm	Max. 2 mm. larger than the anchor diameter	See specification of the manufacturer

Annex B
Characteristic load-carrying capacities

Table 1: Force F_1 , 1 angle bracket / connection timber-timber

type	capacity per nail or screw in the vertical flange ($F_{v,Rk}$) [kN] ²⁾			capacity in the horizontal flange ($F_{ax,Rk}$) [kN] ^{1) 2)}			steel
	4x40/ 5x40	4x50/ 5x40	4x60/ 5x50	4x40/ 5x40	4x50/ 5x40	4x60/ 5x50	bending ($F_{m,Rk}$) [kN]
WZU 15550	1,57	1,87	1,93	1,0	1,3	1,7	1,3
WZUxxx2; t=2,0 mm	1,57	1,87	1,93	0,9	1,1	1,4	0,6
WZUxxx4; t=4,0 mm	1,57	1,87	1,93	0,9	1,1	1,4	2,4

¹⁾ Both nail holes in the horizontal flange next to the bending line have to be nailed or screwed

²⁾ Given is the minimum load-carrying capacity of 4,0 mm nails according to EN 14592 and 5,0 mm screws according to ETA-13/0523. If a wood-based panel interlayer is placed between the connector plate and the timber member, the lateral load-carrying capacity of the nail or screw, respectively, has to take into account the effect of the interlayer.

Table 2: Force F_1 , 1 angle bracket / connection timber-concrete

type	capacity per nail or screw in the vertical flange ($F_{v,Rk}$) [kN] ²⁾			concrete	steel ³⁾			bolt
	4x40/ 5x40	4x50/ 5x40	4x60/ 5x50		bending ($F_{m,Rk}$) [kN]	shear ($F_{v,Rk}$) [kN]	tensile ($F_{t,Rk}$) [kN]	k_{tII}
type WZU 15550	1,57	1,87	1,93	see EN 1992	3,5	17,3	25,8	3,08
type WZUxxx2, t=2,0 mm	1,57	1,87	1,93		23,3	11,6	17,8	3,16
type WZUxxx4, t=4,0 mm	1,57	1,87	1,93		23,9	23,1	35,6	4,00
WZU 342	1,57	1,87	1,93		41,9	11,6	17,8	1,20
WZU 422	1,57	1,87	1,93		62,0	17,3	26,7	1,23
WZU 482	1,57	1,87	1,93		83,4	21,7	33,4	1,50
WHT340, WHT440, WHT540 without base plate	1,57	1,87	1,93		42,0	42,0	63,4	1
WHT340, WHT440, WHT540 Ø17, WHT540 Ø22	1,57	1,87	1,93		63,4	63,4	63,4	1
WHT620 without base plate	1,57	1,87	1,93		42,0	42,0	85,2	1
WHT620 Ø21, WHT620 Ø26	1,57	1,87	1,93		85,2	85,2	85,2	1
WHT740	1,57	1,87	1,93	158	158	158	1	

²⁾ Given is the minimum load-carrying capacity of 4,0 mm nails according to EN 14592 and 5,0 mm screws according to ETA-13/0523. Alternative fasteners according to Table A.3 may be used and their load-carrying capacity calculated based on EN 1995-1-1 and ETA-13/0523. If a wood-based panel interlayer is placed between the connector plate and the timber member, the lateral load-carrying capacity of the nail or screw, respectively, has to take into account the effect of the interlayer.

³⁾ base plates/washers according to the engineering drawings must be used except where otherwise specified

Table 3: Force $F_{2,3}$, 1 angle bracket (nails 4,0 x 50 mm, 4,0 x 60 mm or screws 5,0 x 40 mm, 5,0 x 50 mm)

type	nail-number n_v	nail number n_H	bolt number n_H	$F_{2,3Rk}$ [kN]		bolt $k_{t\perp}$
				timber-timber	timber-concrete	
				WZU 15550 155x50x40x3,0	1,2,4,5,6,7,8,9,11,12	13,14,16,17
WZU2002 200x40x40x2,0	1,2,3,4,5,6,7,8,9,10,11,12, 13,14	16,17,19,20	18	3,1	3,6	1,18 ⁴⁾
WZU2004 200x40x40x4,0	1,2,3,4,5,6,7,8,9,10,11,12, 13,14	16,17,19,20	18	3,1	3,6	1,18 ⁴⁾

⁴⁾ incl. factor 1/0,85 considering hole tolerance

Definitions of forces, their directions and eccentricity

Forces - Beam to beam connection

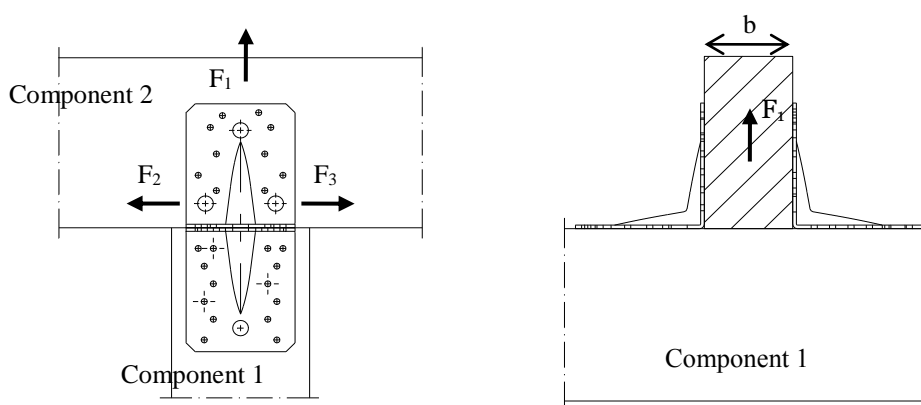

Fastener specification

Holes are marked with numbers referring to the nailing pattern in Annex B.

Single angle bracket per connection

Acting forces

- F_1 Lifting force acting in the central axis of the angle bracket. The component 2 shall be prevented from rotation.
- F_2 and F_3 Lateral force acting in the joint between the component 2 and the component 1 in the component 2 direction. The component 2 shall be prevented from rotation.

Double angle brackets per connection

The angle brackets must be placed at each side opposite to each other, symmetrically to the component axis.

Acting forces

- F_1 Lifting force acting along the central axis of the joint. The load-carrying capacity is twice the load-carrying capacity of a connection with one angle bracket.
- F_2 and F_3 Lateral force acting in the joint between the component 2 and component 1 in the component 2 direction. The load-carrying capacity is twice the load-carrying capacity of a connection with one angle bracket.

Wane

Wane is not allowed, the timber has to be sharp-edged in the area of the angle brackets.

Timber splitting

For the lifting force F_1 it must be checked in accordance with Eurocode 5 or a similar national Timber Code that splitting will not occur.

Connection to timber, concrete or steel with a bolt or metal anchor

The load $F_{B,Ed}$ for the design of a bolt or metal anchor is calculated as:

$$F_{B,t,Ed} = k_{t\parallel} \cdot F_{Ed} \text{ for tensile load}$$

$$F_{B,v,Ed} = k_{t\perp} \cdot F_{Ed} \text{ for shear load}$$

Where:

- $F_{B,t,Ed}$ Bolt tensile load in N
- $F_{B,v,Ed}$ Bolt shear load in N
- k_t Coefficient taking into account the moment arm or hole tolerance, respectively
- F_{Ed} Tensile load F_1 on vertical flap of the angle bracket or shear load $F_{2,3}$ in N

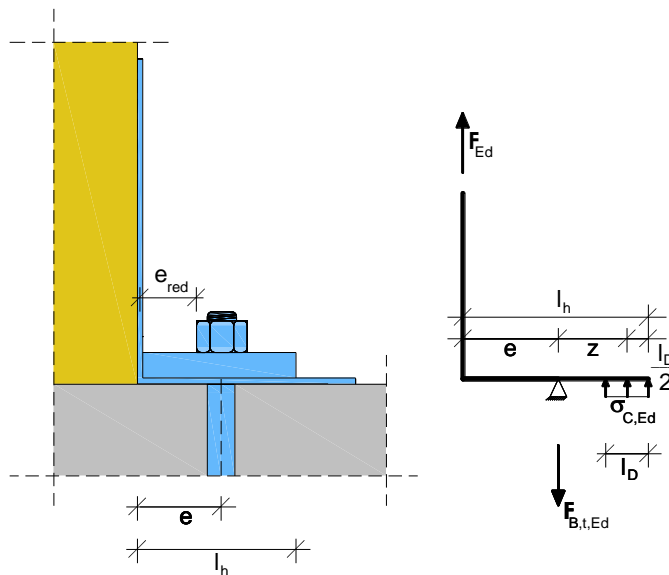

Combined forces

If the forces F_1 and F_2/F_3 act at the same time, the following inequality shall be fulfilled:

$$\left(\frac{F_{1,Ed}}{F_{1,Rd}}\right)^2 + \left(\frac{F_{2,Ed}}{F_{2,Rd}}\right)^2 + \left(\frac{F_{3,Ed}}{F_{3,Rd}}\right)^2 \leq 1$$

The forces F_2 and F_3 are forces with opposite direction. Therefore only one force F_2 or F_3 is able to act simultaneously with F_1 , while the other shall be set to zero.

Rotho Blaas Angle Brackets

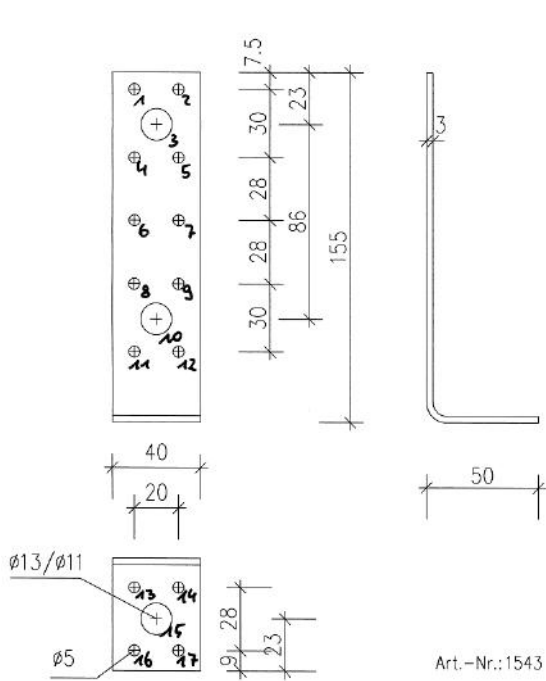

Figure B. 1 Dimensions of type WZU 15550

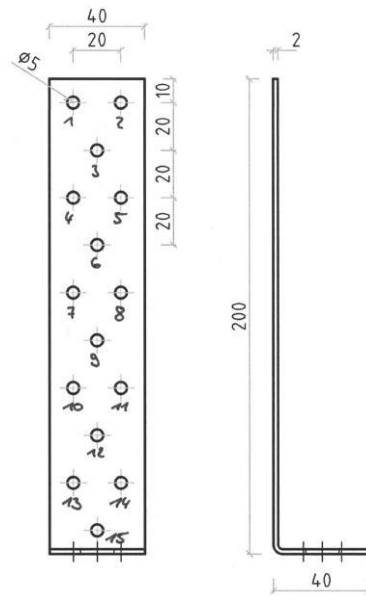

Figure B. 2 Dimensions of type WZU2002

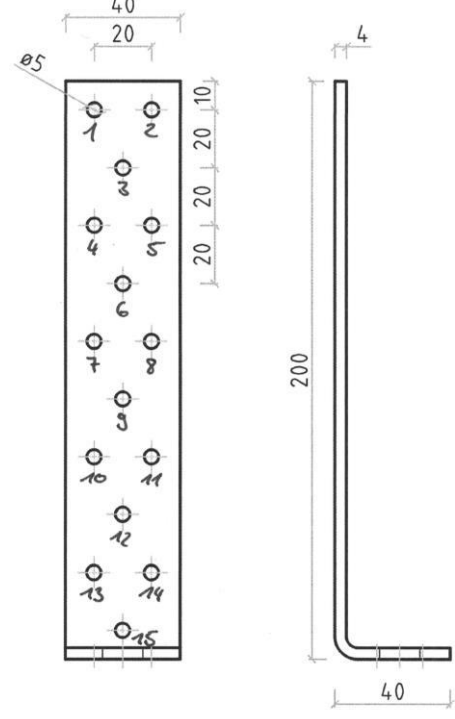

Figure B. 3 Dimensions of type WZU2004

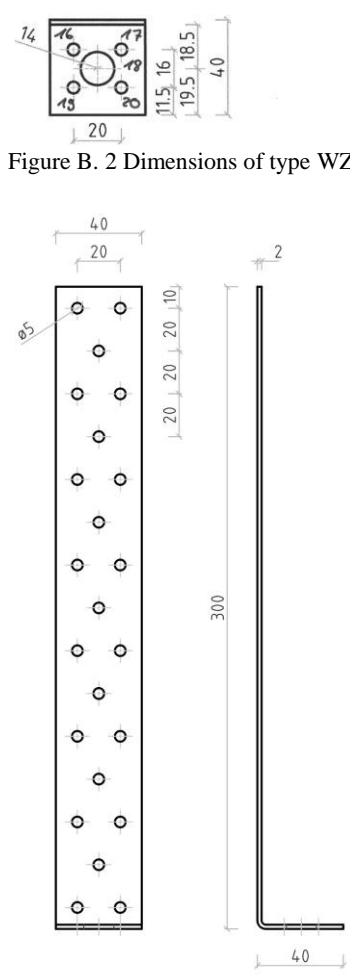
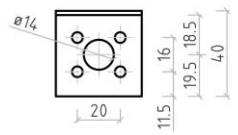
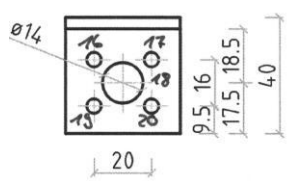

Figure B. 4 Dimensions of type WZU3002



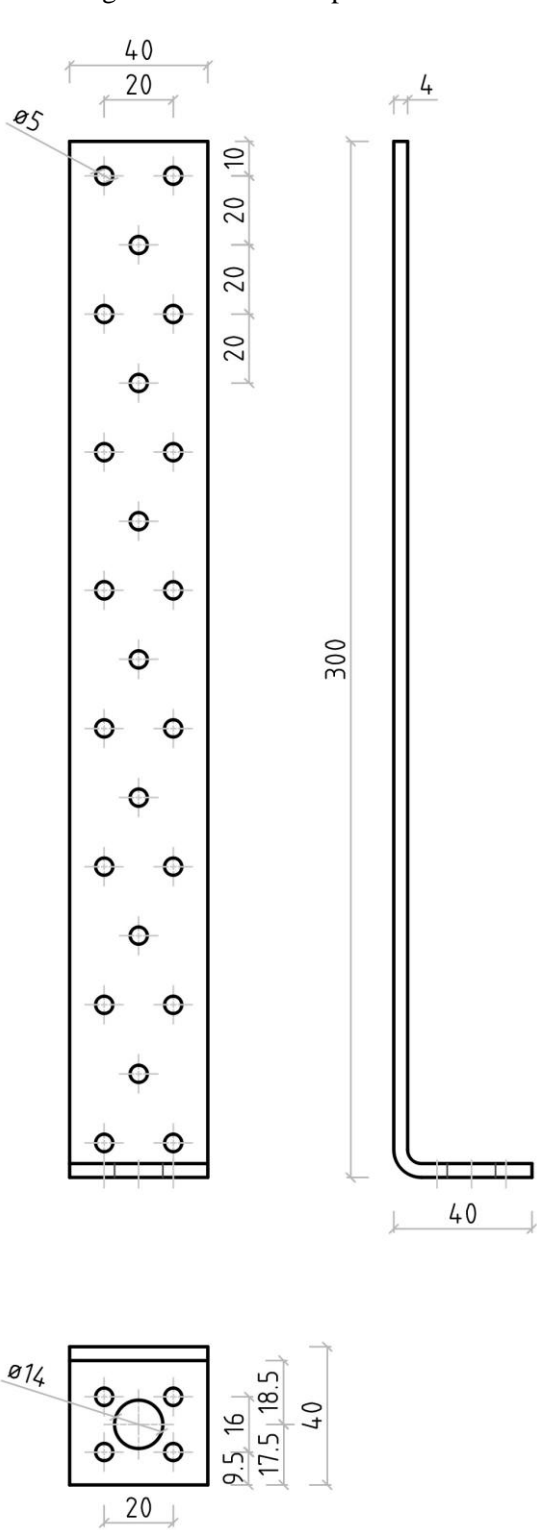

Figure B. 5 Dimensions of type WZU3004

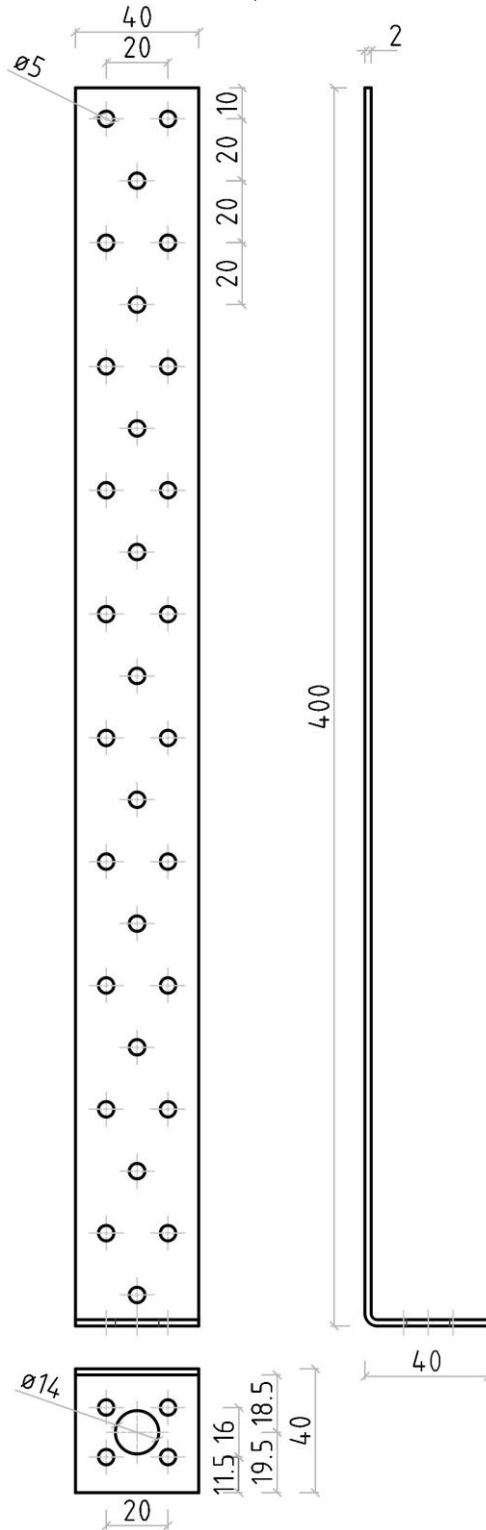

Figure B. 6 Dimensions of type WZU4002

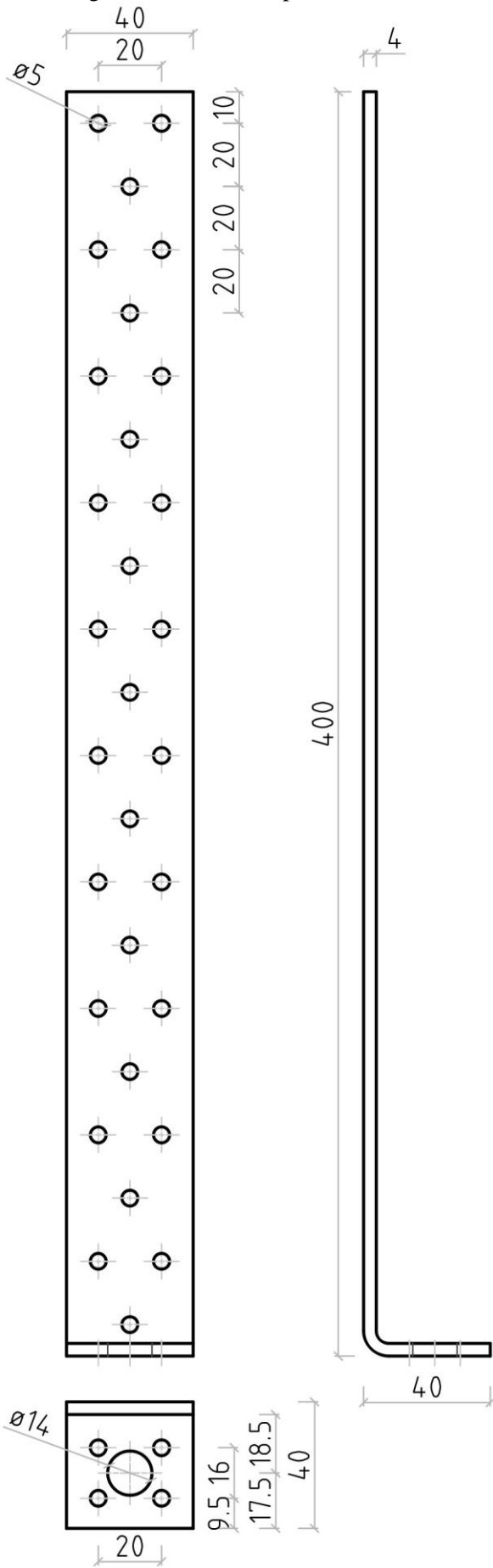

Figure B. 7 Dimensions of type WZU4004

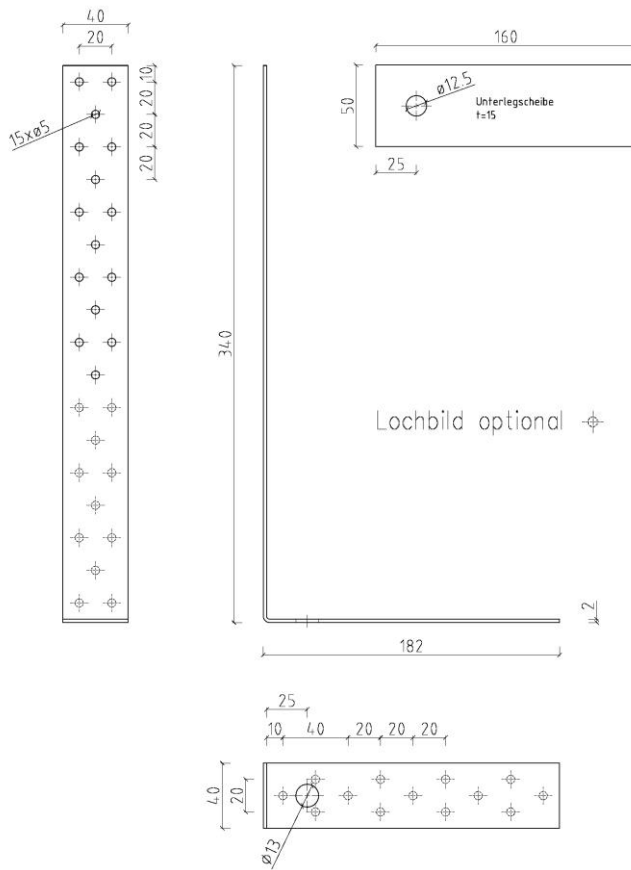

Figure B. 8 Dimensions of type WZU342

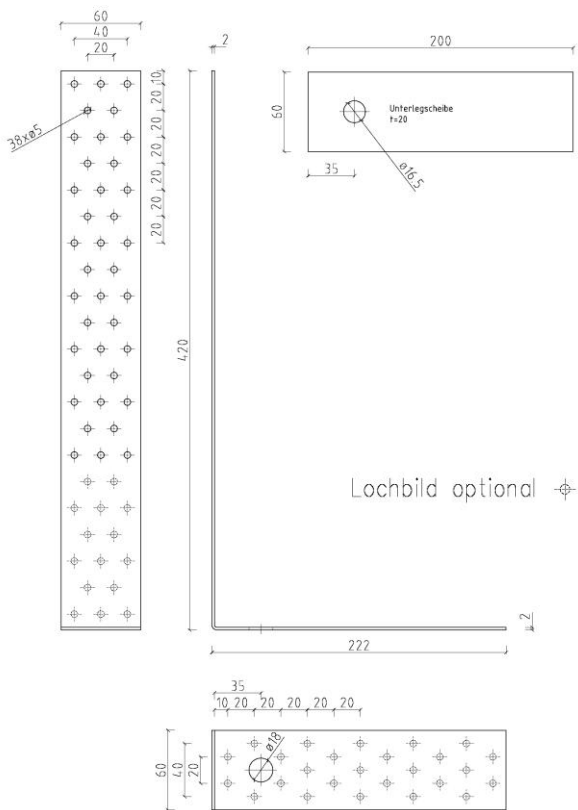

Figure B. 9 Dimensions of type WZU422

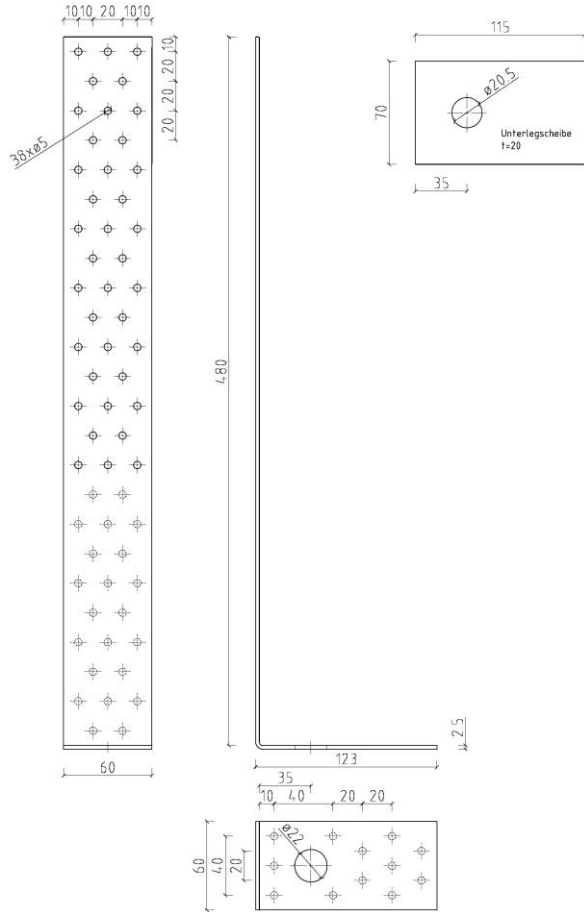

Figure B. 10 Dimensions of type WZU 482

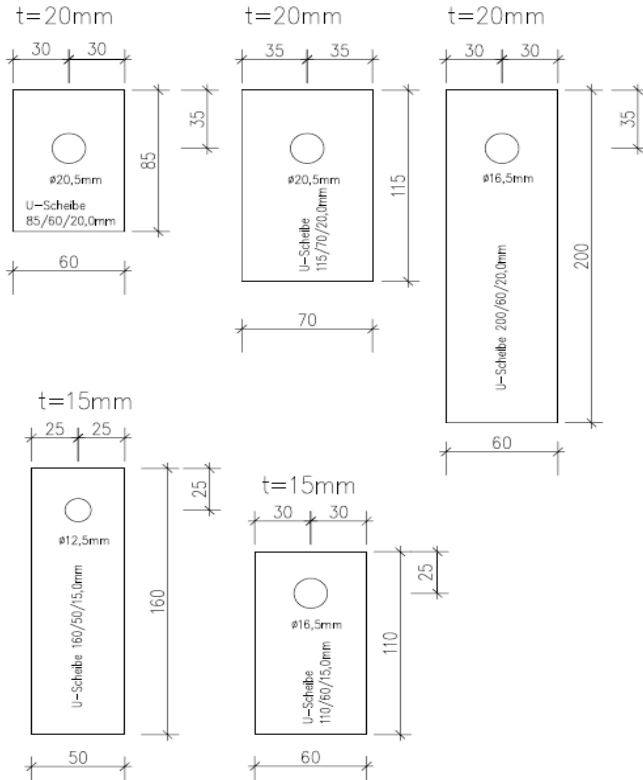

Figure B. 11 Dimensions of washers for hold-downs

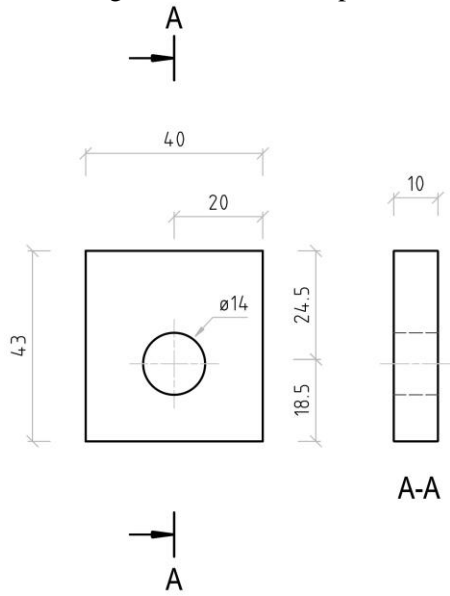

Figure B. 12 Dimensions of washer for type WZU

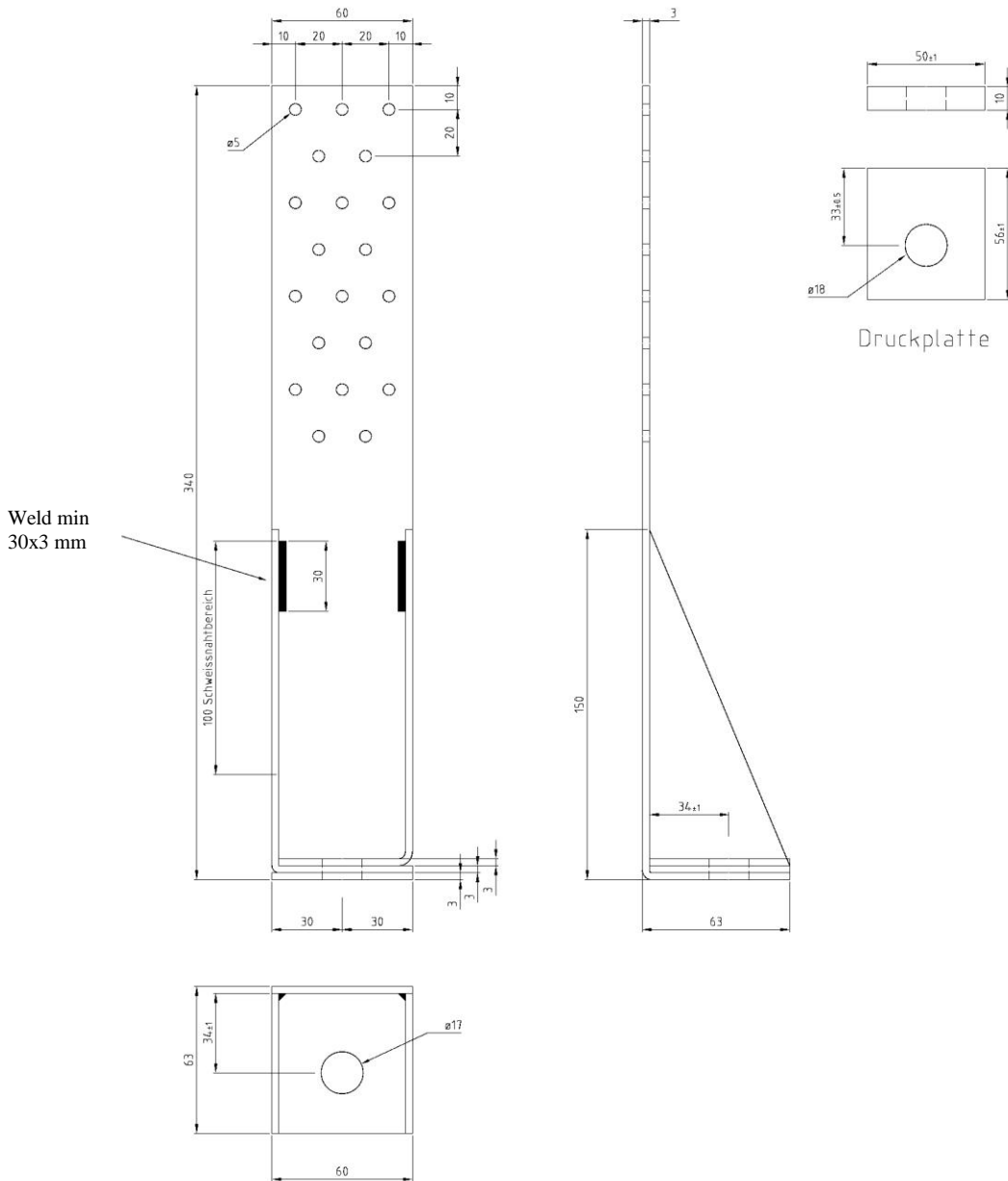

Figure B. 13 Dimensions of type WHT340 (drawing with washer 56x50x10)

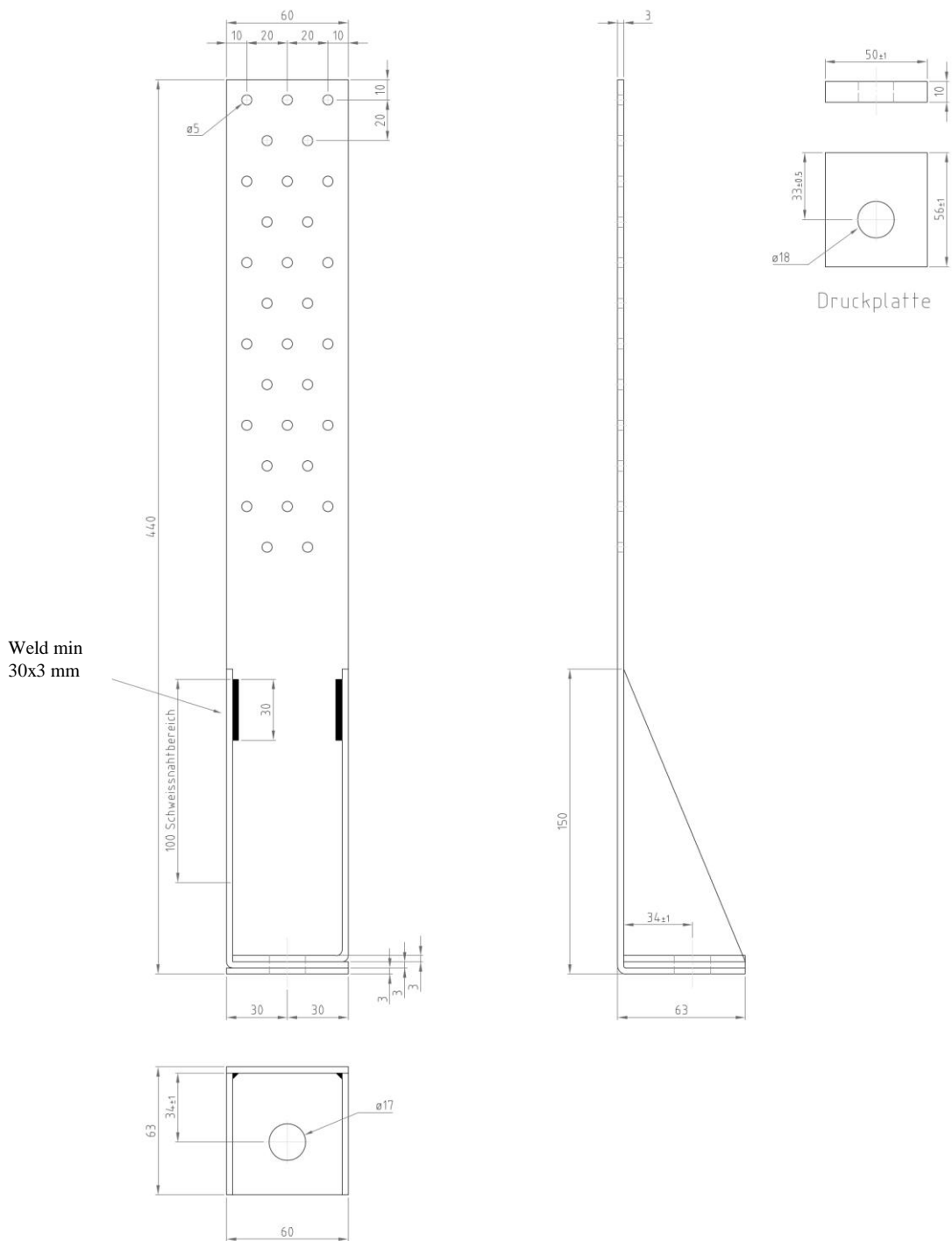

Figure B. 14 Dimensions of type WHT440 (drawing with washer 56x50x10)

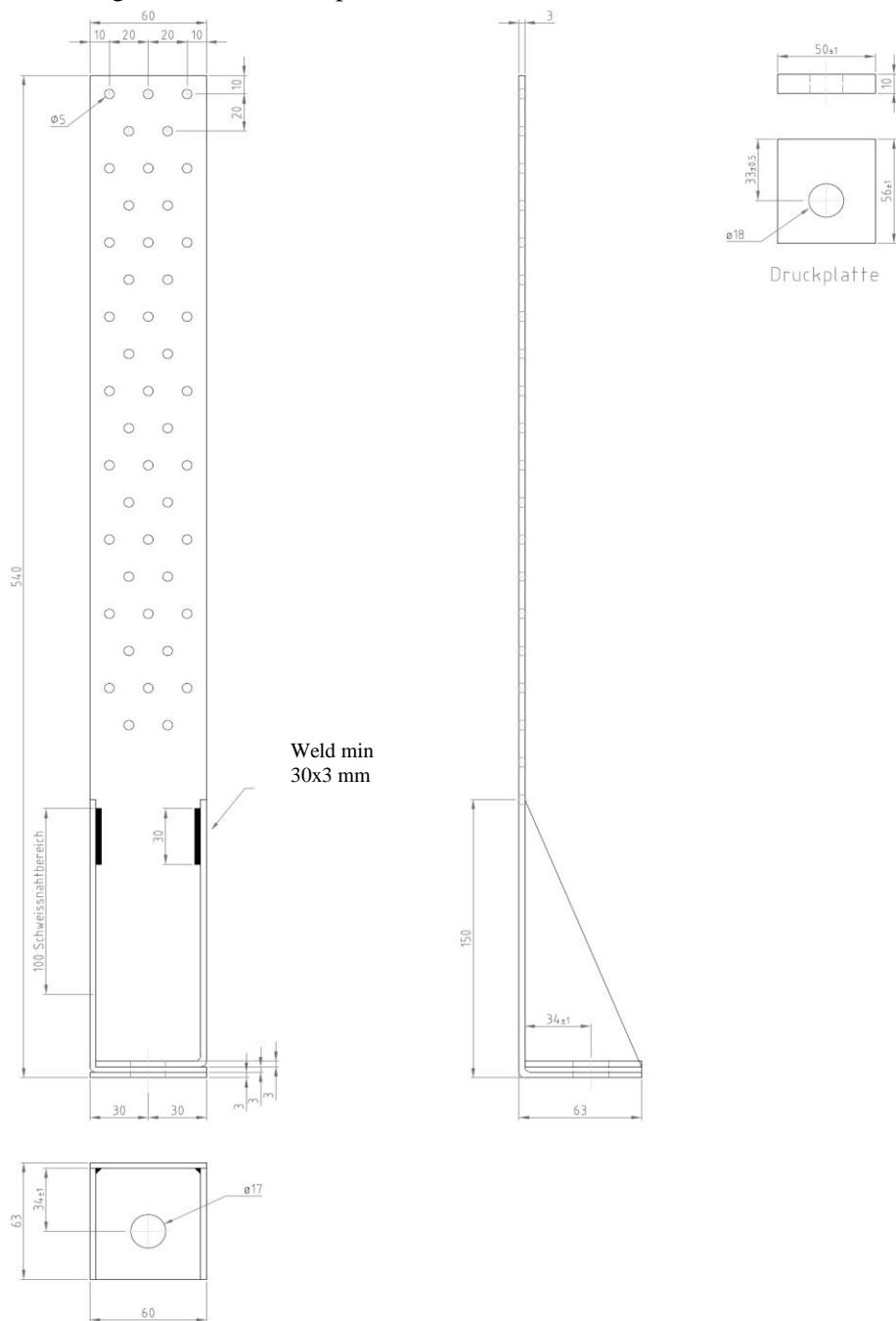

Figure B. 15 Dimensions of type WHT540 (drawing with washer 56x50x10)

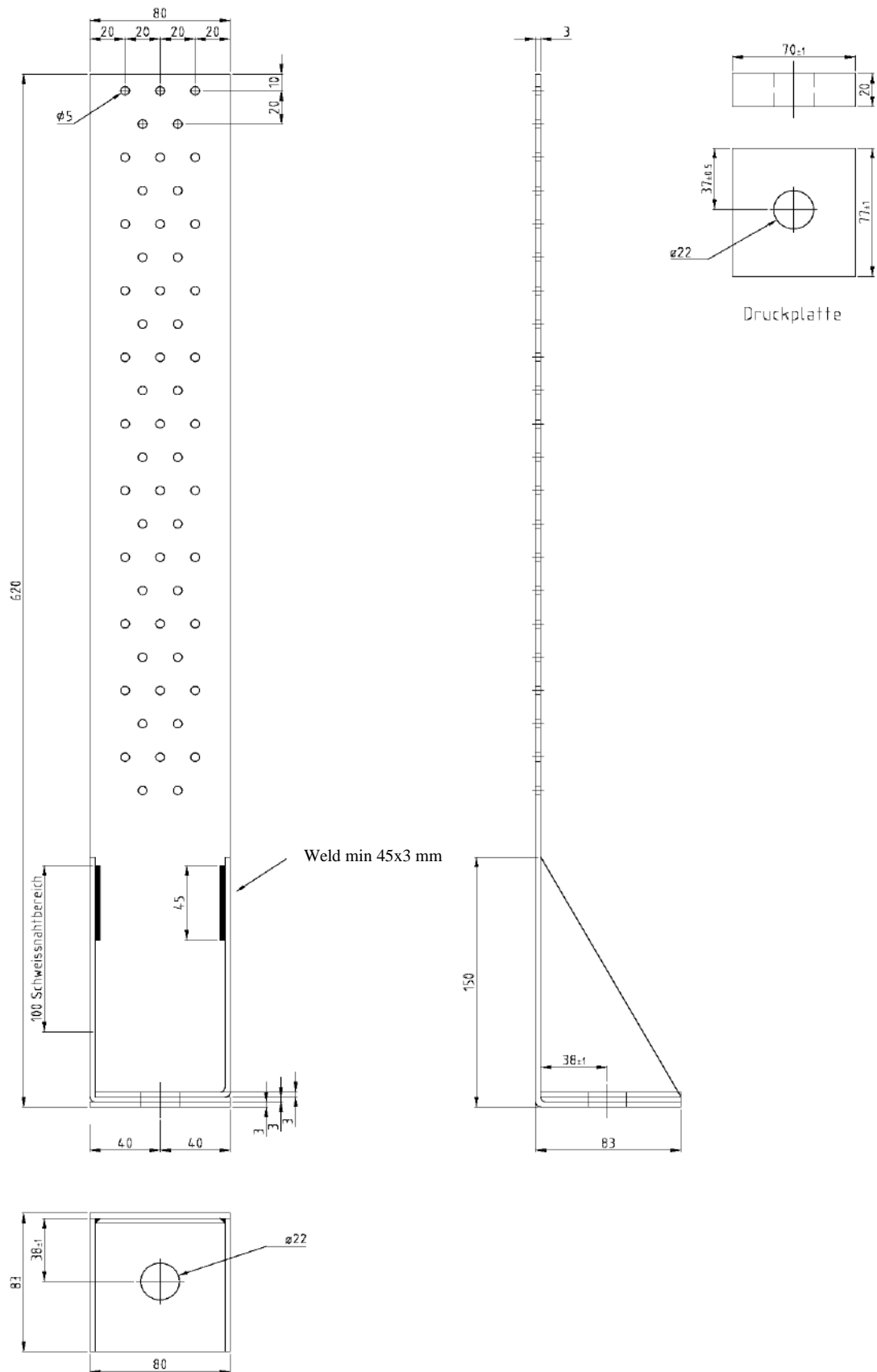

Figure B. 16 Dimensions of type WHT620 (drawing with washer 77x70x20)

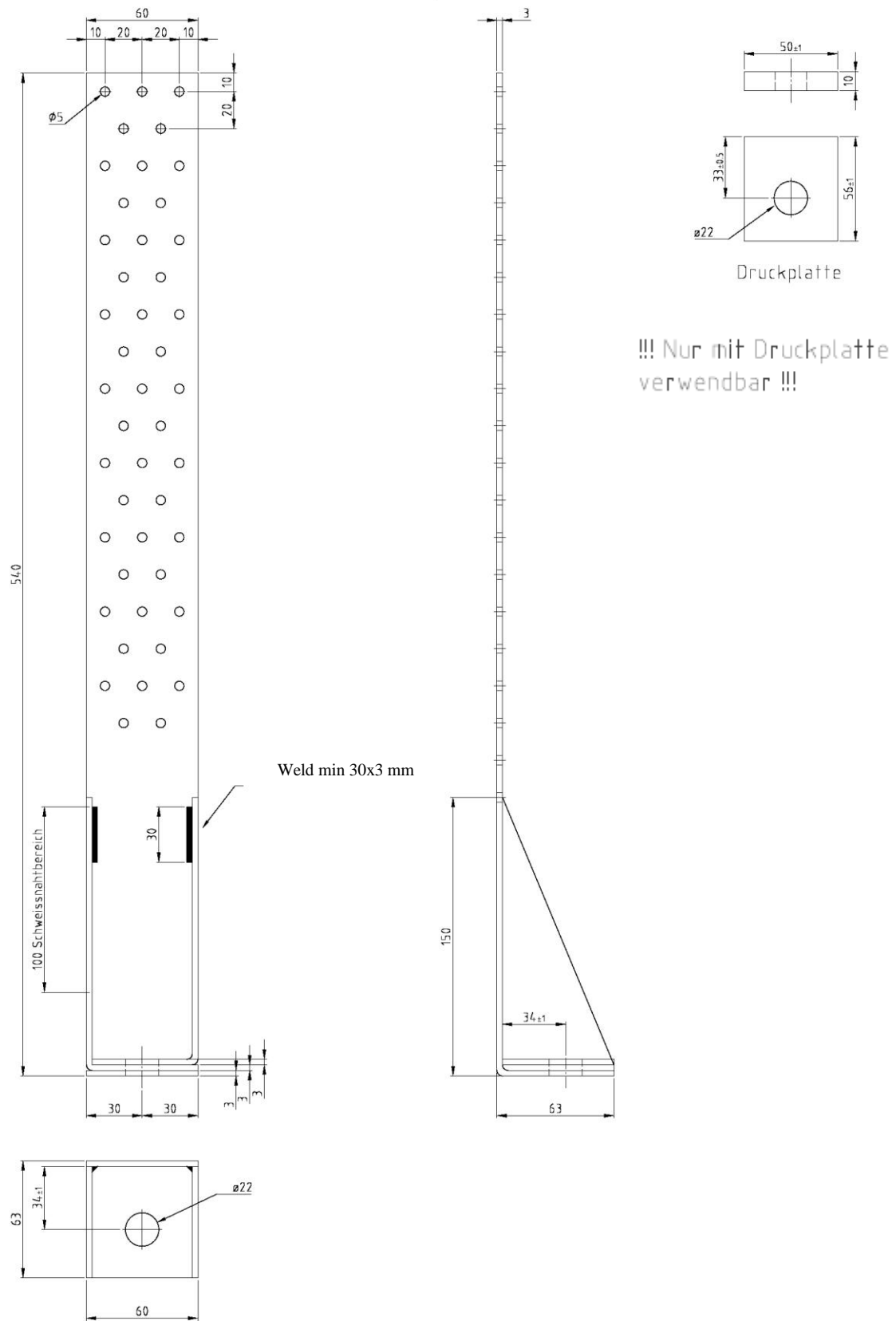

Figure B. 17 Dimensions of type WHT540 Big Hole (with washer 56x50x10)

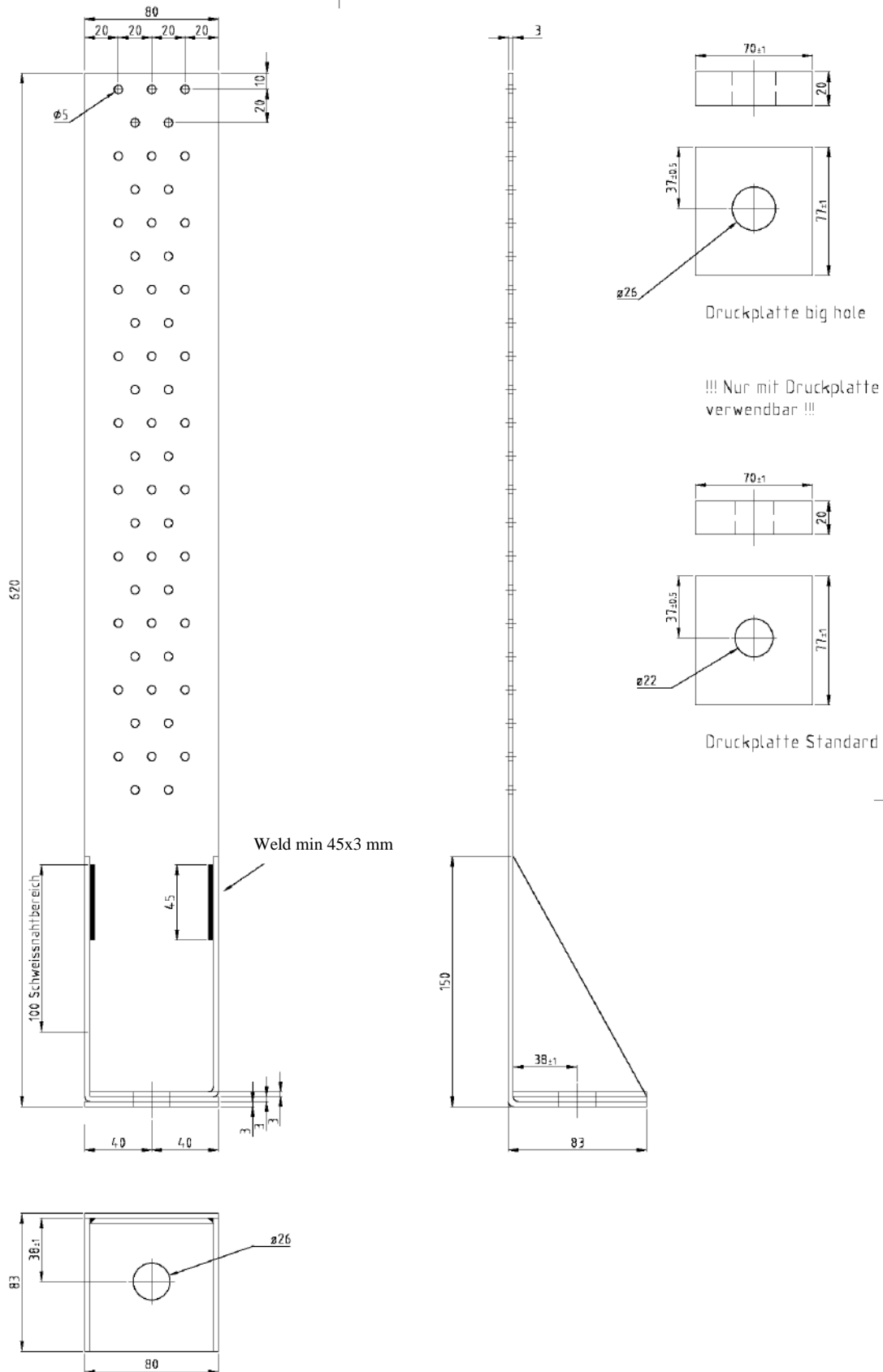

Figure B. 18 Dimensions of type WHT620 Big hole (with washer 77x70x20x $\phi 22$ or 77x70x20x $\phi 26$)

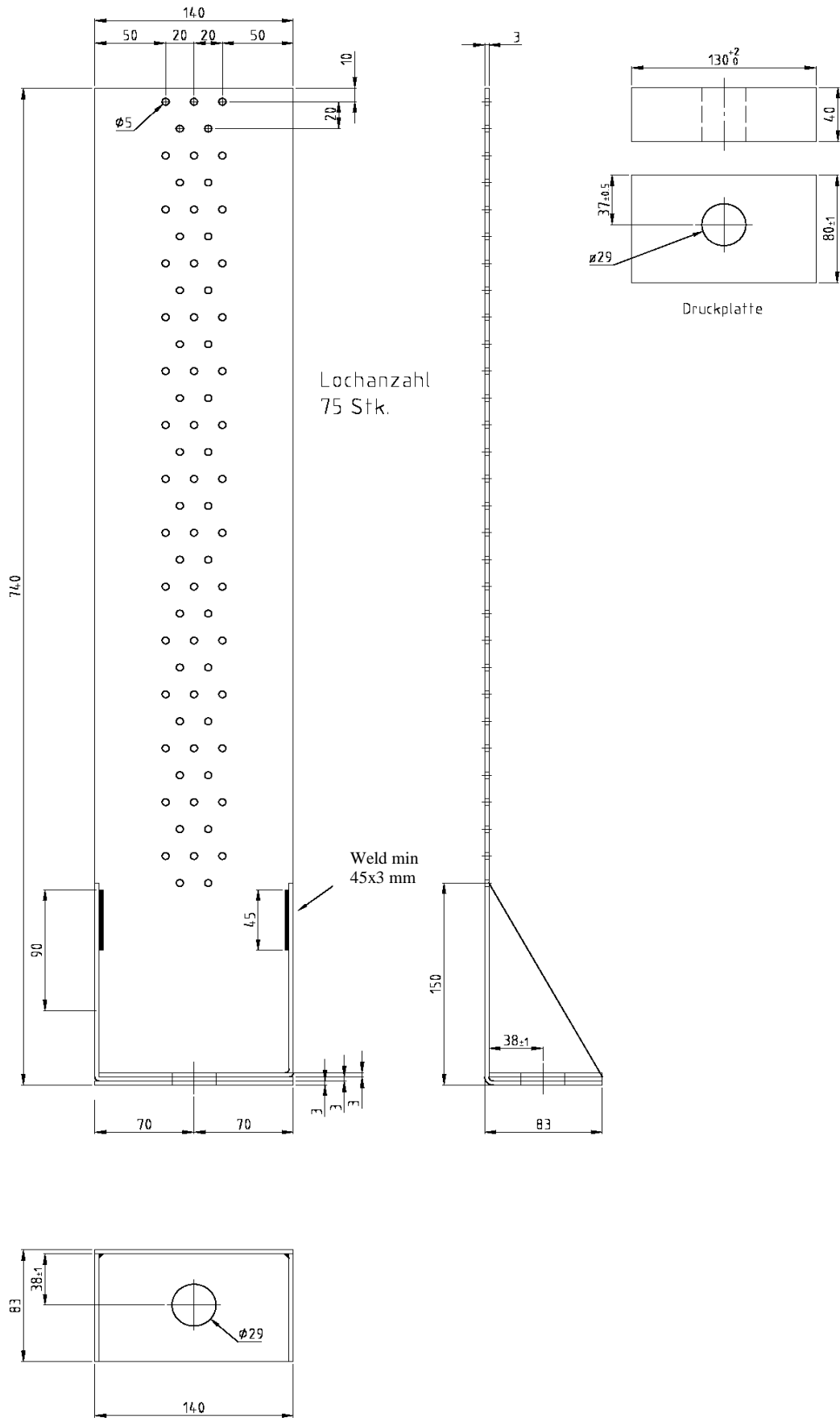

Figure B. 19 Dimensions of type WHT740 (drawing with washer 80x130x40)

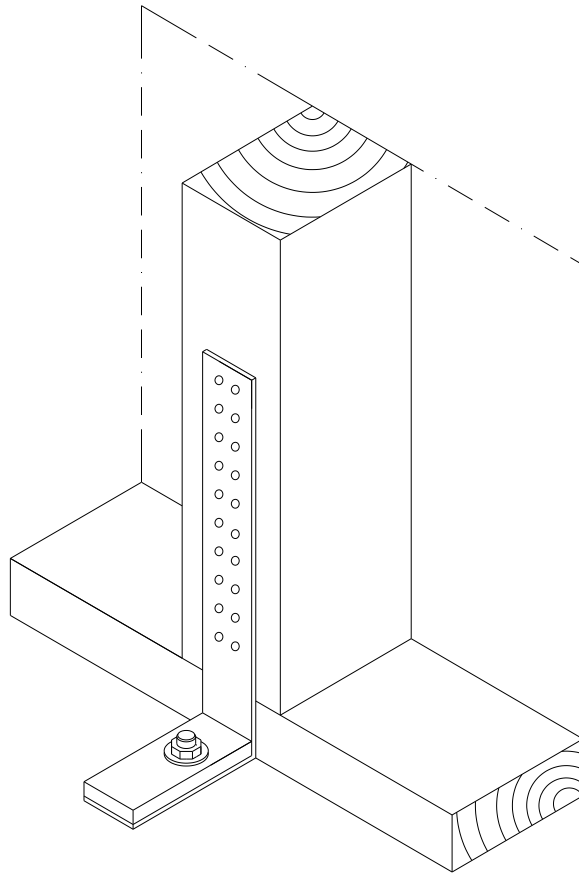

Figure B. 20 Typical installation